

Operating Manual

- BD-S (E1) Incubators with natural convection
- ED-S (E1) Drying and heating ovens with natural convection
- FD-S (E1) Drying and heating ovens with forced convection
- with R-S microprocessor temperature controller

Model	Model version	Art. No.
BD-S 56	BDS056-230V	9090-0016, 9190-0016
	BDS056UL-120V	9090-0017, 9190-0017
BD-S 115	BDS115-230V	9090-0022, 9190-0022
	BDS115UL-120V	9090-0023, 9190-0023
ED-S 56	EDS056-230V	9090-0014, 9190-0014
	EDS056UL-120V	9090-0015, 9190-0015
ED-S 115	EDS115-230V	9090-0020, 9190-0020
	EDS115UL-120V	9090-0021, 9190-0021
FD-S 56	FDS056-230V	9090-0018, 9190-0018
	FDS056UL-120V	9090-0019, 9190-0019
FD-S 115	FDS115-230V	9090-0024, 9190-0024
	FDS115UL-120V	9090-0025, 9190-0025

BINDER GmbH

- ▶ Address: Post office box 102, 78502 Tuttlingen, Germany ▶ Phone: +49 7462 2005 0
- ▶ Fax: +49 7462 2005 100 ▶ Internet: <http://www.binder-world.com>
- ▶ E-mail: info@binder-world.com ▶ Service Hotline: +49 7462 2005 555
- ▶ Service Fax: +49 7462 2005 93 555 ▶ Service E-Mail: service@binder-world.com
- ▶ Service Hotline USA: +1 866 885 9794 or +1 631 224 4340 x3
- ▶ Service Hotline Asia Pacific: +852 390 705 04 or +852 390 705 03
- ▶ Service Hotline Russia and CIS: +7 495 988 15 16

Content

1. SAFETY	4
1.1 Legal considerations	4
1.2 Structure of the safety instructions	4
1.2.1 Signal word panel	4
1.2.2 Safety alert symbol	5
1.2.3 Pictograms	5
1.2.4 Word message panel structure	6
1.3 Localization / position of safety labels on the chamber	6
1.4 Type plate	7
1.5 General safety instructions on installing and operating the chambers	8
1.6 Intended use	9
2. CHAMBER DESCRIPTION	10
2.1 Chamber overview	11
2.2 Triangular instrument panel	12
3. COMPLETENESS OF DELIVERY, TRANSPORTATION, STORAGE, AND INSTALLATION	12
3.1 Unpacking, and checking equipment and completeness of delivery	12
3.2 Guidelines for safe lifting and transportation	13
3.3 Storage	13
3.4 Location of installation and ambient conditions	13
4. INSTALLATION	14
4.1 Installing the racks	14
4.2 Connection to an exhaust/ventilation system (optional)	15
4.3 Electrical connection	15
5. R-S CONTROLLER OVERVIEW	16
5.1 Menu structure overview	17
6. START UP	18
6.1 Adjusting air change	18
7. TEMPERATURE SET -POINT ENTRY	18
8. SELECTING THE TEMPERATURE UNIT	19
8.1 Setting the temperature unit	19
9. OVERTEMPERATURE PROTECTION	19
9.1 Overtemperature protective device (class 1)	19
9.2 Safety controller	20
9.2.1 Setting the safety controller	20
9.2.2 Alarm message and proceeding in case of an alarm	21
10. TIMER FUNCTIONS	21
10.1 Timer function "Delayed On"	21
10.1.1 Setting the timer run-time	22
10.2 Timer function "Delayed Off"	22
10.2.1 Setting the timer run-time	22
10.3 Timer function "Temperature dependent Delayed Off"	23
10.3.1 Setting the timer run-time	23



11. RAMP FUNCTION	24
11.1 Setting the ramp	24
11.2 Setting the gradient	25
11.3 Display of the ramp course	25
11.4 Turning off the ramp function	25
12. OPTIONS	26
12.1 Data logger kits (option)	26
13. MAINTENANCE, CLEANING, AND SERVICE	26
13.1 Maintenance intervals, service	26
13.2 Cleaning and decontamination	27
13.2.1 Cleaning	27
13.2.2 Decontamination	28
13.3 Sending the chamber back to BINDER GmbH	29
14. DISPOSAL	30
14.1 Disposal of the transport packing	30
14.2 Decommissioning	30
14.3 Disposal of the chamber in the Federal Republic of Germany	30
14.4 Disposal of the chamber in the member states of the EU except for the Federal Republic of Germany	31
14.5 Disposal of the chamber in non-member states of the EU	32
15. TROUBLESHOOTING	33
16. TECHNICAL DESCRIPTION	34
16.1 Factory calibration and adjustment	34
16.2 Definition of usable volume	34
16.3 Over current protection	34
16.4 Technical data	35
16.5 Equipment and options (extract)	37
16.6 Accessories and spare parts (extract)	37
16.7 Dimensions	38
16.7.1 BD-S 56	38
16.7.2 BD-S 115	39
16.7.3 ED-S 56	40
16.7.4 ED-S 115	41
16.7.5 FD-S 56	42
16.7.6 FD-S 115	43
17. CERTIFICATES AND DECLARATIONS OF CONFORMITY	44
17.1 EU Declaration of Conformity for BD-S	44
17.2 EU Declaration of Conformity for ED-S	46
17.3 EU Declaration of Conformity for FD-S	48
18. PRODUCT REGISTRATION	50
19. CONTAMINATION CLEARANCE CERTIFICATE	51
19.1 For chambers located outside the USA and Canada	51
19.2 For chambers located in the USA and Canada	54

Dear customer,

For the correct operation of the chambers, it is important that you read this operating manual completely and carefully and observe all instructions as indicated. Failure to read, understand and follow the instructions may result in personal injury. It can also lead to damage to the chamber and/or poor equipment performance

1. Safety

This operating manual is part of the components of delivery. Always keep it handy for reference. The device should only be operated by laboratory personnel especially trained for this purpose and familiar with all precautionary measures required for working in a laboratory. Observe the national regulations on minimum age of laboratory personnel To avoid injuries and damage observe the safety instructions of the operating manual.

	 WARNING
	<p>Failure to observe the safety instructions. Serious injuries and chamber damage.</p> <ul style="list-style-type: none"> ➤ Observe the safety instructions in this operating manual ➤ Carefully read the complete operating instructions of the chambers.

1.1 Legal considerations

This operating manual is for informational purposes only. It contains information for installing, start-up, operation and maintenance of the product. Note: the contents and the product described are subject to change without notice.

Understanding and observing the instructions in this operating manual are prerequisites for hazard-free use and safety during operation and maintenance. In no event shall BINDER be held liable for any damages, direct or incidental arising out of or related to the use of this manual.

This operating manual cannot cover all conceivable applications. If you would like additional information, or if special problems arise that are not sufficiently addressed in this manual, please ask your dealer or contact us directly by phone at the number located on page one of this manual

Furthermore, we emphasize that the contents of this operating manual are not part of an earlier or existing agreement, description, or legal relationship, nor do they modify such a relationship. All obligations on the part of BINDER derive from the respective purchase contract, which also contains the entire and exclusively valid statement of warranty administration. The statements in this manual neither augment nor restrict the contractual warranty provisions.

1.2 Structure of the safety instructions

In this operating manual, the following safety definitions and symbols indicate dangerous situations following the harmonization of ISO 3864-2 and ANSI Z535.6.

1.2.1 Signal word panel

Depending on the probability of serious consequences, potential dangers are identified with a signal word, the corresponding safety color, and if appropriate, the safety alert symbol.

 DANGER
<p>Indicates an imminently hazardous situation that, if not avoided, will result in death or serious (irreversible) injury.</p>

WARNING

Indicates a potentially hazardous situation which, if not avoided, could result in death or serious (irreversible) injury

CAUTION

Indicates a potentially hazardous situation which, if not avoided, may result in moderate or minor (reversible) injury

CAUTION

Indicates a potentially hazardous situation which, if not avoided, may result in damage to the product and/or its functions or of a property in its proximity.

1.2.2 Safety alert symbol





Use of the safety alert symbol indicates a **risk of injury**.

Observe all measures that are marked with the safety alert symbol in order to avoid death or injury.

1.2.3 Pictograms

Warning signs			
Electrical hazard	Hot surface	Explosive atmosphere	Stability hazard
Lifting hazard	Risk of corrosion and / or chemical burns	Harmful substances	Biohazard
Pollution Hazard			
Mandatory action signs			
Mandatory regulation	Read operating instructions	Disconnect the power plug	Lift with several persons
Environment protection	Wear protective gloves	Wear safety goggles	

Prohibition signs			
 Do NOT touch	 Do NOT spray with water		

	Information to be observed in order to ensure optimum function of the product.
---	---



1.2.4 Word message panel structure

Type / cause of hazard. Possible consequences. ∅ Instruction how to avoid the hazard: prohibition. ➤ Instruction how to avoid the hazard: mandatory action.
--

Observe all other notes and information not necessarily emphasized in the same way, in order to avoid disruptions that could result in direct or indirect injury or property damage.

1.3 Localization / position of safety labels on the chamber

The following labels are located on the chamber:

Pictograms (Warning signs)	Service label
 Hot surface <ul style="list-style-type: none"> • ED-S, FD-S: outer chamber door • BD-S: on the glass door handle • On the exhaust air flap 	
 Read operating manual <ul style="list-style-type: none"> • UL chamber: outer chamber door 	

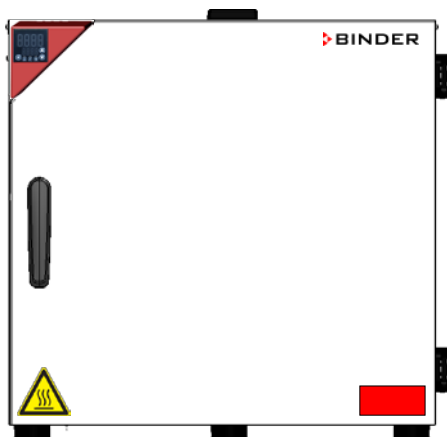

ED-S, FD-S

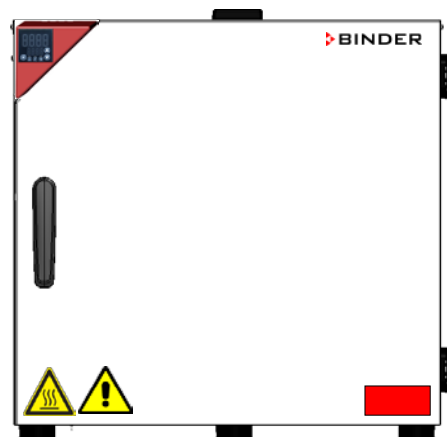

ED-S-UL, FD-S-UL

Figure 1: Position of labels on the chamber front (example: ED-S, FD-S size 56)

	Keep safety labels complete and legible.
---	---

Replace safety labels that are no longer legible. Contact BINDER Service for these replacements.



1.4 Type plate

The type plate is located on the left-hand side of the chamber, bottom right-hand.



Figure 2: Type plate (example BD-S 115-230V regular chamber)

Indications of the type plate (example)		Information
BINDER		Manufacturer: BINDER GmbH
BD-S 115		Model designation
Incubator		Chamber name: Incubator
Drying and heating oven		Chamber name: Drying and heating oven
Serial No.	000000000000	Serial No of the chamber
Built	2018	Year of construction
Nominal temperature	70 °C 158 °F	Nominal temperature
IP protection	20	IP type of protection acc. to EN 60529
Temp. safety device	DIN 12880	Temperature safety device acc. to standard DIN 12880
Class	3.1	Class of temperature safety device
Art. No.	9090-0022	Art. no. of the chamber
Project No.	---	Optional: Special application acc. to project no.
1,30 kW		Nominal power
5,7 A		Nominal current
230 V / 50 Hz		Nominal voltage +/- 10% at the indicated power frequency
230 V / 60 Hz		
1 N ~		Current type

Symbol on the type plate	Information
	CE conformity marking
	Electrical and electronic equipment manufactured / placed on the market in the EU after 13 August 2005 and to be disposed of in a separate collection according to Directive 2012/19/EU on waste electrical and electronic equipment (WEEE).

1.5 General safety instructions on installing and operating the chambers



With regard to operating the chambers and to the installation location, please observe the DGUV guidelines 213-850 on safe working in laboratories (formerly BGI/GUV-I 850-0, BGR/GUV-R 120 or ZH 1/119, issued by the employers' liability insurance association) (for Germany).

BINDER GmbH is only responsible for the safety features of the chamber provided skilled electricians or qualified personnel authorized by BINDER perform all maintenance and repair, and if components relating to chamber safety are replaced in the event of failure with original spare parts.



To operate the chamber, use only original BINDER accessories or accessories from third-party suppliers authorized by BINDER. The user is responsible for any risk caused by using unauthorized accessories.

	CAUTION
	<p>Danger of overheating. Damage to the chamber.</p> <ul style="list-style-type: none"> ⊘ Do NOT install the chamber in unventilated recesses. ➤ Ensure sufficient ventilation for dispersal of the heat.

Do not operate the chambers in hazardous locations.

	 DANGER
	<p>Explosion hazard. Danger of death.</p> <ul style="list-style-type: none"> ⊘ Do NOT operate the chamber in potentially explosive areas. ➤ KEEP explosive dust or air-solvent mixtures AWAY from the chamber.

The chambers do not dispose of any measures of explosion protection.

	 DANGER
	<p>Explosion hazard. Danger of death.</p> <ul style="list-style-type: none"> ⊘ Do NOT introduce any substance into the chamber which is combustible or explosive at working temperature. ⊘ NO explosive dust or air-solvent mixture in the inner chamber.



Any solvent contained in the charging material must not be explosive or inflammable. I.e., irrespective of the solvent concentration in the steam room, NO explosive mixture with air must form. The temperature inside the chamber must lie below the flash point or below the sublimation point of the charging material. Familiarize yourself with the physical and chemical properties of the charging material, as well as the contained moisture constituent and its behavior with the addition of heat energy.

Familiarize yourself with any potential health risks caused by the charging material, the contained moisture constituent or by reaction products that may arise during the temperature process. Take adequate measures to exclude such risks prior to putting the chamber into operation.

	 DANGER
	<p>Electrical hazard. Danger of death.</p> <ul style="list-style-type: none"> ⊘ The chamber must NOT become wet during operation or maintenance.

The chambers were produced in accordance with VDE regulations and were routinely tested in accordance to VDE 0411-1 (IEC 61010-1).

During and shortly after operation, the temperature of the inner surfaces almost equals the set-point.

	 CAUTION
	<p>The glass doors and glass door handles (BD-S), inner chamber, exhaust air flap, door window (option), and the door gaskets will become hot during operation.</p> <p>Danger of burning.</p> <ul style="list-style-type: none"> ∅ Do NOT touch the glass doors, inner surfaces, exhaust air flap, door window, access ports, door gaskets, or the charging material during operation. ∅ FD-S: Do not place the power cable over the door gap when the chamber is hot after operation.

1.6 Intended use

The chambers are suitable for exact tempering of harmless materials and for drying and heat treatment of solid or pulverized charging material, as well as bulk material, using the supply of heat. They can be used to dry e.g. glassware, and for warm storage of liquids in containers.

Because of their precise temperature accuracy the incubators BD-S are especially useful for incubation of cultures at a standard temperature of 37 °C / 98.6 °F.

A solvent content must not be explosive or flammable. A mixture of any component of the charging material with air must NOT be explosive. The operating temperature must lie below the flash point or below the sublimation point of the charging material. Any component of the charging material must NOT be able to release toxic gases.

Other applications are not approved.

The chambers are not classified as medical devices as defined by the Medical Device Directive 93/42/EEC.

Do NOT use the chamber for drying processes when large quantities of vapor would form and result in condensation.



Due to the special demands of the Medical Device Directive 93/42/EEC, these ovens are not qualified for sterilization of medical devices as defined by the directive.



Observing the instructions in this operating manual and conducting regular maintenance work (chap. 13) is part of the intended use.





WARNING: If customer should use a BINDER chamber running in non-supervised continuous operation, we strongly recommend in case of inclusion of irrecoverable specimen or samples to split such specimen or samples and store them in at least two chambers, if this is feasible.



The charging material shall not contain any corrosive ingredients that may damage the machine components. Such ingredients include in particular acids and halides. Any corrosive damage caused by such ingredients is excluded from liability by BINDER GmbH.

The chambers do not dispose of any measures of explosion protection.

 	 DANGER
<p>Explosion or implosion hazard. Danger of poisoning. Danger of death.</p> <ul style="list-style-type: none"> ∅ Do NOT introduce any substance combustible or explosive at working temperature into the chamber, in particular no energy sources such as batteries or lithium-ion batteries. ∅ NO explosive dust or air-solvent mixture in the inner chamber. ∅ Do NOT introduce any substance which could lead to release of toxic gases. 	

In case of foreseeable use of the device there is no risk for the user through the integration of the chamber into systems or by special environmental or operating conditions in the sense of EN 61010-1:2010. For this, the intended use of the chamber and all its connections must be observed.

2. Chamber description

BINDER incubators BD-S and drying and heating ovens ED-S and FD-S are equipped with an electronic PID-controller with digital display.

	<p>The incubators BD-S indicate the temperature with an accuracy of a tenth of a degree. The drying and heating ovens ED-S and FD-S indicate the temperature with an accuracy of one degree.</p>
--	---

All chambers are heated electrically. Incubators BD-S and drying and heating ovens ED-S are ventilated naturally. Drying and heating ovens FD-S are ventilated by fan-assisted, forced-air circulation.

The concept of air conduction guarantees high level of spatial and time-based temperature precision, thanks to the direct and distributed air circulation into the interior. With FD-S, the fan supports exact attainment and maintenance of the desired temperature accuracy.

The chambers are regularly equipped with an overtemperature safety device class 1 acc. to DIN12880:2007 and with an overtemperature safety controller (overtemperature temperature safety device class 2 (ED-S, FD-S) or class 3.1(BD-S) acc. to DIN12880:2007), see chap. 8.

The inner chamber and the inside of the doors are made of stainless steel V2A (German material no. 1.4016, US equivalent AISI 430). Drying and heating ovens ED-S and FD-S: When operating the chambers at temperatures above 150 °C / 302 °F, the impact of the oxygen in the air may cause discoloration of the metallic surfaces (yellowish-brown or blue) by natural oxidation processes. These colorations are harmless and will in no way impair the function or quality of the chamber.

All chamber functions are easy and comfortable to use thanks to their clear arrangement. Major features are easy cleaning of all chamber parts and avoidance of undesired contamination.

Temperature ranges see technical data (chap. 16.4).

2.1 Chamber overview

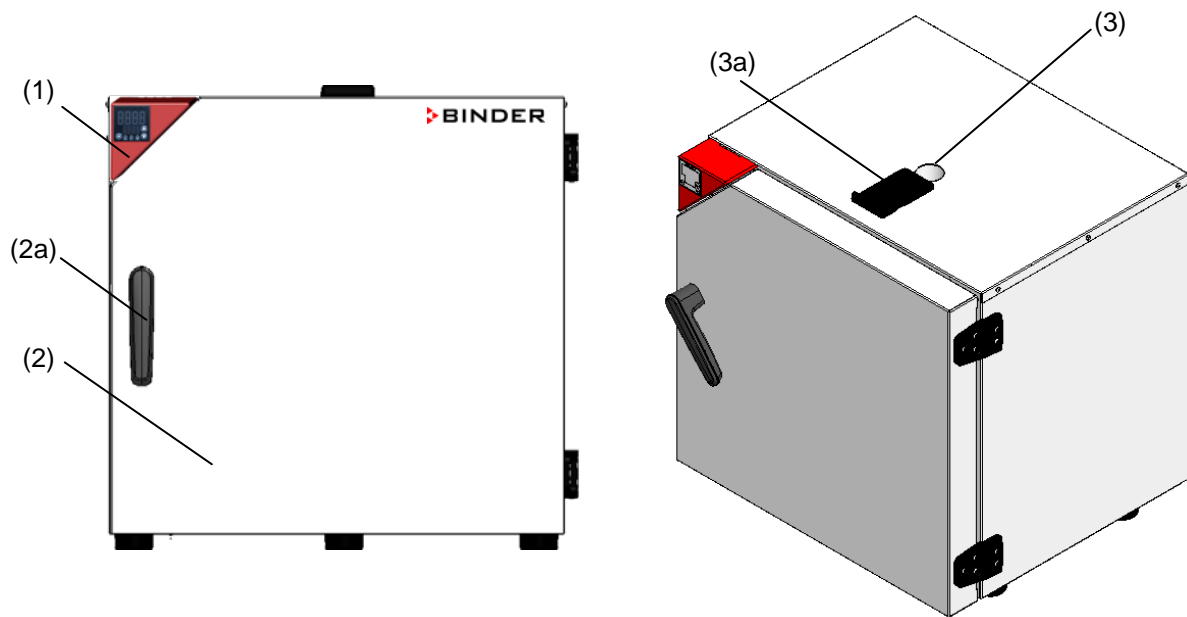

Figure 3: Chamber overview, closed chamber

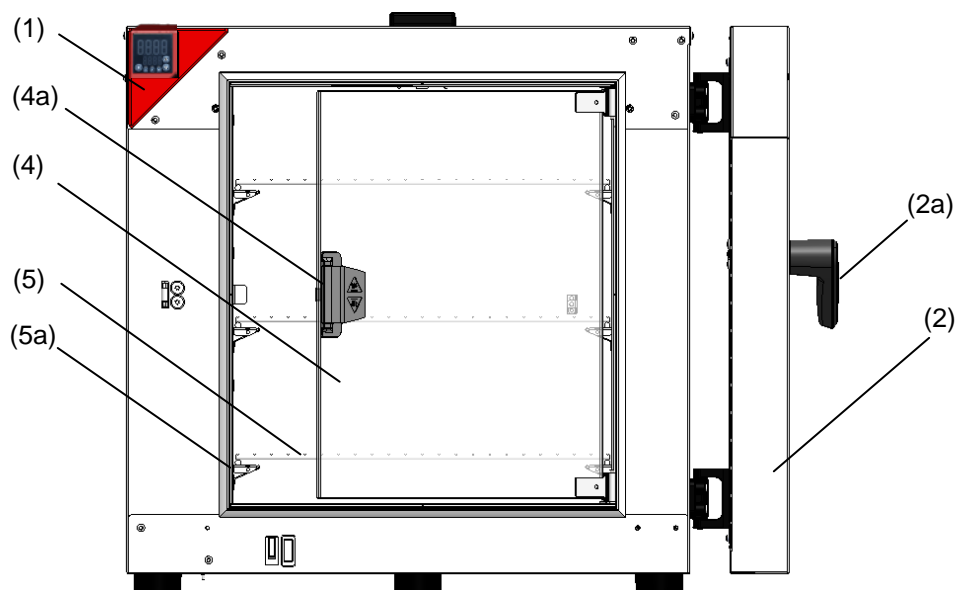

Figure 4: Chamber overview, open chamber with glass door (BD-S)

- (1) Triangular instrument panel with R-S controller
- (2) Outer door
- (2a) Outer door handle
- (3) Exhaust air outlet
- (3a) Exhaust air flap
- (4) Glass door (BD-S)
- (4a) Glass door handle (BD-S)
- (5) Rack
- (5a) Rack support

2.2 Triangular instrument panel

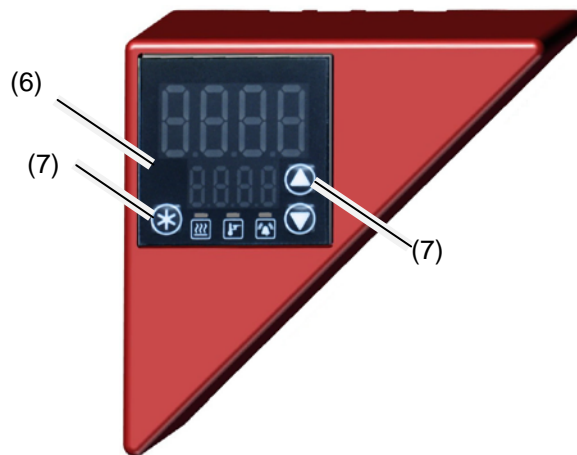

Figure 5: Triangular instrument panel with R-S controller

- (6) Controller display
- (7) Functional controller buttons





3. Completeness of delivery, transportation, storage, and installation

3.1 Unpacking, and checking equipment and completeness of delivery

After unpacking, please check the chamber and its optional accessories, if any, based on the delivery receipt for completeness and for transportation damage. Inform the carrier immediately if transportation damage has occurred.

The final tests of the manufacturer may have caused traces of the racks on the inner surfaces. This has no impact on the function and performance of the chamber.

Please remove any transportation protection devices and adhesives in/on the chamber and on the doors and take out the operating manuals and accessory equipment.

  	 CAUTION
	<p>Sliding or tilting of the chamber. Damage to the chamber. Risk of injury by lifting heavy loads.</p> <ul style="list-style-type: none"> Ø Do NOT lift or transport the chamber using the door handle or the door. ➤ Lift the chamber from the pallet at its four lower corners with the aid of 2 people..

If you need to return the chamber, please use the original packing and observe the guidelines for safe lifting and transportation (chap. 3.2).

For disposal of the transport packing, see chap. 14.1.





Note on second-hand chambers (Ex-Demo-Units):

Second-hand chambers are chambers that have been used for a short time for tests or exhibitions. They are thoroughly tested before resale. BINDER ensures that the chamber is technically sound and will work flawlessly.

Second-hand chambers are marked with a sticker on the chamber door. Please remove the sticker before commissioning the chamber.

3.2 Guidelines for safe lifting and transportation

After operation please observe the guidelines for temporarily decommissioning the chamber (chap. 14.2).

	<table border="1"> <tr> <th colspan="2" style="background-color: yellow; text-align: center;">  CAUTION </th> </tr> <tr> <td colspan="2"> <p>Sliding or tilting of the chamber. Damage to the chamber.</p> <p>Risk of injury by lifting heavy loads.</p> <ul style="list-style-type: none"> ➤ Transport the chamber only in its original packaging. ➤ Secure the chamber with transport straps for transport. ⊘ Do NOT lift or transport the chamber using the door handle or the door. ➤ Lift chamber at its four lower corners with the aid of 2 people, and place it on a transport pallet with wheels. Push the pallet to the desired site and then lift the chamber from the pallet at its four lower corners. </td> </tr> </table>	 CAUTION		<p>Sliding or tilting of the chamber. Damage to the chamber.</p> <p>Risk of injury by lifting heavy loads.</p> <ul style="list-style-type: none"> ➤ Transport the chamber only in its original packaging. ➤ Secure the chamber with transport straps for transport. ⊘ Do NOT lift or transport the chamber using the door handle or the door. ➤ Lift chamber at its four lower corners with the aid of 2 people, and place it on a transport pallet with wheels. Push the pallet to the desired site and then lift the chamber from the pallet at its four lower corners. 	
 CAUTION					
<p>Sliding or tilting of the chamber. Damage to the chamber.</p> <p>Risk of injury by lifting heavy loads.</p> <ul style="list-style-type: none"> ➤ Transport the chamber only in its original packaging. ➤ Secure the chamber with transport straps for transport. ⊘ Do NOT lift or transport the chamber using the door handle or the door. ➤ Lift chamber at its four lower corners with the aid of 2 people, and place it on a transport pallet with wheels. Push the pallet to the desired site and then lift the chamber from the pallet at its four lower corners. 					

- Permissible ambient temperature range during transport: -10 °C to +60 °C / 14 °F to 140 °F.

You can order transport packing and pallets for transportation purposes from BINDER Service.

3.3 Storage

Intermediate storage of the chamber is possible in a closed and dry room. Observe the guidelines for temporary decommissioning (chap. 14.2).

- Permissible ambient temperature range during storage: -10 °C to +60 °C / 14 °F to 140 °F.
- Permissible ambient humidity: max. 70 % r.H., non-condensing

When after storage in a cold location you transfer the chamber to its warmer installation site, condensation may form. Before start-up, wait at least one hour until the chamber has attained ambient temperature and is completely dry.

3.4 Location of installation and ambient conditions

Set up the chamber on an even and non-flammable surface, free from vibration and in a well-ventilated, dry location and align it using a spirit level. The site of installation must be capable of supporting the chamber's weight (see technical data, chap. 16.4). The chambers are designed for setting up inside a building (indoor use).

	<table border="1"> <tr> <th colspan="2" style="background-color: yellow; text-align: center;"> CAUTION </th> </tr> <tr> <td colspan="2"> <p>Danger of overheating. Damage to the chamber.</p> <ul style="list-style-type: none"> ⊘ Do NOT set up chambers in non-ventilated recesses. ➤ Ensure sufficient ventilation for dispersal of the heat. </td> </tr> </table>	CAUTION		<p>Danger of overheating. Damage to the chamber.</p> <ul style="list-style-type: none"> ⊘ Do NOT set up chambers in non-ventilated recesses. ➤ Ensure sufficient ventilation for dispersal of the heat. 	
CAUTION					
<p>Danger of overheating. Damage to the chamber.</p> <ul style="list-style-type: none"> ⊘ Do NOT set up chambers in non-ventilated recesses. ➤ Ensure sufficient ventilation for dispersal of the heat. 					

- Permissible ambient temperature range during operation: +18 °C up to +40 °C / 64.4 °F to 104 °F. At elevated ambient temperature values, fluctuations in temperature can occur.



The ambient temperature should not be substantially higher than the indicated ambient temperature of +22 °C +/- 3 °C / 71.6 °F ± 5.4 °F to which the specified technical data relate. For other ambient conditions, deviations from the indicated data are possible.

- Permissible ambient humidity: 70 % r.H. max., non-condensing.
- Installation height: max. 2000 m / 6562 ft. above sea level.

When placing several chambers of the same size side by side, maintain a minimum distance of 250 mm / 9.84 in between each chamber. Wall distances: rear 160 mm / 6.30 in, sides 100 mm / 3.94 in. Spacing above the chamber of at least 160 mm / 6.30 in must also be accounted for.

The chambers must NOT be stacked.

	CAUTION
	<p>Danger by stacking. Damage to the chambers.</p> <p>⊘ Do NOT place chambers on top of each other.</p>

To completely separate the chamber from the power supply, you must disconnect the power plug. Install the chamber in a way that the power plug is easily accessible and can be easily pulled in case of danger.

For the user there is no risk of temporary overvoltages in the sense of EN 61010-1:2010.

Do not install or operate the chamber in potentially explosive areas.

	DANGER
	<p>Explosion hazard. Danger of death.</p> <p>⊘ Do NOT operate the chamber in potentially explosive areas. ➤ KEEP explosive dust or air-solvent mixtures AWAY from the vicinity of the chamber.</p>

4. Installation

4.1 Installing the racks

Insert 4 rack supports for each rack into the slots of the lateral inner chamber walls. They serve as a support for the rack.

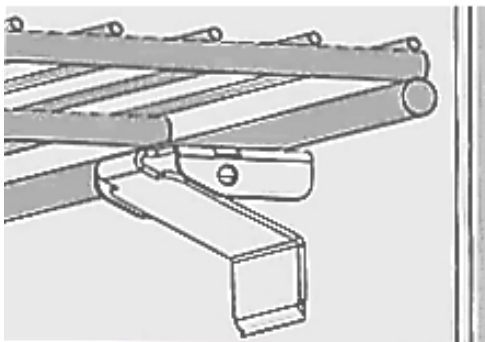

Figure 6: Rack with rack support

4.2 Connection to an exhaust/ventilation system (optional)

Active suction from the chamber must only be effected together with external air. Therefore, the exhaust air outlet on the top of the chamber shall not be immediately connected to an active exhaust system.

When connecting to an active exhaust system, proceed as follows:

- Remove the black exhaust air flap.
- Perforate the connecting piece of the exhaust system or place an exhaust air funnel in a distance of 3-5 cm / 1 to 2 in from the exhaust air outlet. The funnel's opening must be at least twice as large as the diameter of the exhaust air outlet.



If improperly connected to an active exhaust/ventilation system, the spatial temperature exactitude (uniformity), the heating-up and recovering times as well as the maximum temperature of the chamber may be negatively affected.



CAUTION

The exhaust air outlet on the top of the chamber will become hot during operation. Danger of burning.

∅ Do NOT touch the exhaust air outlet during operation.

4.3 Electrical connection

The chambers are supplied ready for connection and come with an IEC connector plug.

Model	Power plug of the power cable	Nominal voltage +/- 10% at the indicated power frequency	Current type	Chamber fuse
BD-S056-230V	Grounded plug	230 V at 50 Hz 230 V at 60 Hz	1N~	6,3 A
ED-S056-230V FD-S056-230V	Grounded plug	230 V at 50 Hz 230 V at 60 Hz	1N~	6,3 A
BD-S115-230V	Grounded plug	230 V at 50 Hz 230 V at 60 Hz	1N~	6,3 A
ED-S115-230V FD-S115-230V	Grounded plug	230 V at 50 Hz 230 V at 60 Hz	1N~	6,3 A
BD-S056UL-120V	NEMA 5-15P	120 V at 50 Hz 120 V at 60 Hz	1N~	12,5 A
ED-S056UL-120V FD-S056UL-120V	NEMA 5-15P	120 V at 50 Hz 120 V at 60 Hz	1N~	12,5 A
BD-S115UL-120V	NEMA 5-15P	120 V at 50 Hz 120 V at 60 Hz	1N~	12,5 A
ED-S115UL-120V FD-S115UL-120V	NEMA 5-15P	120 V at 50 Hz 120 V at 60 Hz	1N~	12,5 A

- The domestic socket must also provide a protective conductor. Make sure that the connection of the protective conductor of the domestic installations to the chamber's protective conductor meets the latest technology. The protective conductors of the socket and plug must be compatible!
- Prior to connection and start-up, check the power supply voltage. Compare the values to the specified data located on the chamber's type plate (left-hand side of the chamber, chap. 1.4).

- When connecting, please observe the regulations specified by the local electricity supply company and as well as the VDE directives (for Germany). We recommend the use of a residual current circuit breaker.
- Only use original connection cables from BINDER.
- FD-S: Do not place the power cable over the door gap when the chamber is hot after operation.
- Pollution degree (acc. to IEC 61010-1): 2
- Over-voltage category (acc. to IEC 61010-1): II

	CAUTION
	<p>Danger of incorrect power supply voltage. Damage to the equipment.</p> <ul style="list-style-type: none"> ➤ Check the power supply voltage before connection and start-up. ➤ Compare the power supply voltage with the data indicated on the type plate.



See also electrical data (chap. 16.4).



	<p>To completely separate the chamber from the power supply, you must disconnect the power plug. Install the chamber in a way that the power plug is easily accessible and can be easily pulled in case of danger.</p>
---	--



5. R-S controller overview



Figure 7: Normal display (sample values)

Displays of menus or value setting (example)	
	<p>Upper display (red): Function depending on the menu. In Normal display: Actual temperature value.</p>
	<p>Lower display (green): Function depending on the menu. In Normal display: Temperature set-point.</p>

Buttons to navigate the manues and enter the values	
	<p>The arrow buttons serve to navigate and to enter the values</p>
	<p>The confirmation button serves to select a menu point and to confirm the entered value. The confirmation must be made within 60 seconds. If in Normal display the confirmation button is pressed down for approx. 3 seconds, the display changes to standby mode (the lower display in Normal display shows "OFF"). To activate the display, press down the standby button again.</p>

Status-LEDs for information about chamber conditions	
	Heating active
	Safety controller active
	Collective alarm

Return to Normal display:

If no entry is made for 120 seconds, the controller returns from each menu to normal display.

To directly return from each menu to normal display, keep pressed down the **confirmation button** and press the **arrow-up button**, if appropriate, several times. Each time you press the **arrow-up button** the controller goes back one level.

5.1 Menu structure overview

Normal display

- Temperature set-point entry directly via the **confirmation button** (chap. 7).

Quick access

Access from Normal display via the **arrow buttons**:

- Setting the safety controller value (chap. 9.2.1)
- Setting the timer run-time for timer function "Delayed Off" (chap. 10.2.1)

"Setup" menu

The menu is password protected ("S.Loc"). Enter password "10" and select the submenu.

- Setting the temperature unit (chap. 8.1)

"Advanced configuration" menu

- The menu is password protected ("A.Loc"). Enter password "20" and select the submenu.
- Setting the timer run-time for timer function "Delayed On" (chap. 10.1.1)
- Setting the timer run-time for timer function "Temperature dependent Delayed Off" (chap. 10.3.1)
- Setting the ramp gradient (chap. 11.2)

6. Start up

Insert the plug into a suitable socket (chap. 4.2).

If there is no indication on the controller, press the **confirmation button** until the display lights up.

The controller now shows normal display (chap. 5). If a ramp gradient was active prior to turning off the chamber, the effective ramp set-point is displayed alternately with the target set-point (chap. 11



Warming chambers may release odors in the first few days after commissioning. This is not a quality defect. To reduce odors quickly we recommend heating up the chamber to its nominal temperature for one day and in a well-ventilated location.

6.1 Adjusting air change

Opening the black exhaust air flap on top of the chamber serves to adjust the air change.

BD-S, ED-S: The open exhaust air flap allows increasing fresh air circulation through the exhaust air outlet.

FD-S: The open exhaust air flap and fan operation allow fresh air to come in through the ventilation gaps.

Note: If the exhaust air flap is completely open, the spatial temperature accuracy can be negatively influenced.

For connection to an exhaust/ventilation system see chap. 4.2.

7. Temperature set -point entry

Normal display shows the temperature set-point (lower display) and the actual temperature value (upper display).

BD-S: Setting with an accuracy of a tenth of a degree. Setting range: 0 °C / 31 °F up to 70 °C / 158 °F

ED-S, FD-S: Setting with an accuracy one degree. Setting range: 0 °C / 31 °F up to 250 °C / 482 °F

Setting:

In Normal display press the **confirmation button**.

The current temperature set-point (lower display) flashes.

Enter the desired temperature set-point with the **arrow buttons** and confirm with the **confirmation button**.

The controller will now equilibrate to the new temperature set-point.

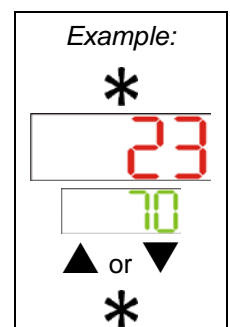

Check and/or adjust the safety controller following any changes of the set-point (chap. 8).

8. Selecting the temperature unit

You can set the temperature unit to degrees Celsius °C or degrees Fahrenheit °F.

If the unit is changed, all temperature values are converted accordingly.

Also when specifying the ramp function (see chap. 11) this setting is accordingly taken as the basis.

	C = degrees Celsius	0 °C = 31°F	Conversion: [Value in °F] = [Value in °C] * 1,8 + 32
	F= degrees Fahrenheit	100 °C = 212°F	

8.1 Setting the temperature unit

Simultaneously press the **confirmation button** and the **arrow-up button** to access the „Setup“ menu. The password entry display „S.Loc“ flashes.

Enter the password “10” with the **arrow-up button** and confirm with the **confirmation button**.

Press the **arrow-up button** to access the “Unit” menu (temperature unit). The „Unit“ menu is shown with the current temperature unit.

Press the **confirmation button** to activate the entry. The display “Unit” flashes.

Select the desired unit with the **arrow buttons** and confirm with the **confirmation button**.

Keep pressed down the **confirmation button** and press the **arrow-up button** to return to Normal display.

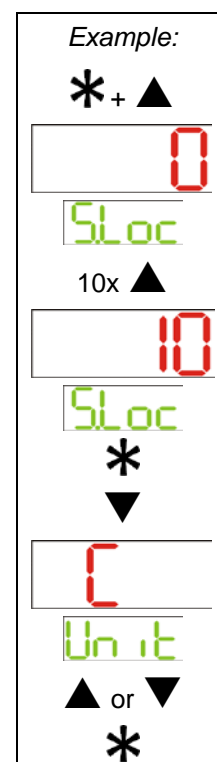

9. Overtemperature protection

9.1 Overtemperature protective device (class 1)

The chambers are equipped with an internal temperature safety device, class 1 acc. to DIN 12880:2007. It serves to protect the unit and prevents dangerous conditions caused by major defects.

If the cut-off temperature is reached, the over temperature protective device permanently turns off the unit. The user cannot restart the device again. The protective cut-off device is located internally. Only a service specialist can replace it. Therefore, please contact an authorized service provider or BINDER service.

Cut-off temperature values:

BD-S: 90 °C / 194 °F

ED-S, FD-S: 318 °C / 604.4 °F

9.2 Safety controller

The chambers are regularly equipped with an adjustable electronic safety controller. It serves to protect the chamber, its environment and the contents against exceeding the maximum permissible temperature. Please observe the DGUV guidelines 213-850 on safe working in laboratories (formerly BGI/GUV-I 850-0, BGR/GUV-R 120 or ZH 1/119, issued by the employers' liability insurance association) (for Germany).

Depending on the chamber type the safety controller acts as an over temperature safety device class 2 ("temperature limiter") or class 3.1 ("temperature protection") acc. to DIN 12880:2007.



Check the setting regularly and adjust it following any changes of the set-point.

- **BD-S: Safety controller class 3.1**

The safety controller class 3.1 limits the temperature inside the chamber to the entered safety controller set-point. In the event of a fault (if this maximum temperature is exceeded), it takes over the control to this value. This status is reported visually by an alarm message.

The safety controller keeps control of the chamber until the chamber temperature cools down below the safety controller set-point value.

- **ED-S, FD-S: Safety controller class 2**

The safety controller class 2 limits the temperature inside the chamber to the entered safety controller set-point. In the event of a fault (if this maximum temperature is exceeded) the safety controller completely turns off the heating until manual reset. This status is reported visually by an alarm message.

Function check:

Check the safety controller at appropriate intervals for its functionality. It is recommended that the authorized operating personnel should perform such a check, e.g., before starting a longer work procedure.

9.2.1 Setting the safety controller

A limit temperature is entered as the safety controller set-point, i.e. the absolute maximum permitted temperature value.

BD-S: Setting with an accuracy of a tenth of a degree. 0 °C / 31 °F up to 80 °C / 176 °F

ED-S, FD-S: Setting with an accuracy one degree. 0 °C / 31 °F up to 260 °C / 500 °F



Regularly check the safety controller setting relating to the entered temperature set-point
Set the safety controller set-point by approx. 2 °C to 5 °C above the desired temperature set-point.

Setting:

In Normal display press the **arrow-up button** to access the "Octl" (safety controller) setting menu.

The current safety controller value is shown (upper display)

Press the **confirmation button**. The display "Octl" flashes.

Enter the desired safety controller value with the **arrow buttons** and confirm with **confirmation button**.

The new safety controller value is activated.

Press the **arrow-down button** to return to Normal display.

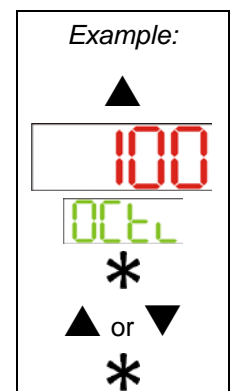

9.2.2 Alarm message and proceeding in case of an alarm



The status LED "Heating active" is lit.

- **BD-S: Safety controller class 3.1**

The safety controller keeps control of the chamber until the chamber temperature cools down below the entered safety controller value. First the heating turns off. As soon as the inner chamber temperature has cooled down below the safety controller set-point, the heating is released and temperature control is resumed by the controller.

If the safety controller class 3.1 has repeatedly taken over control, we recommend proceeding as follows:

- Disconnect the chamber from the power supply.
- Have an expert examine and rectify the cause of the fault.
- Restart the chamber

- **ED-S, FD-S: Safety controller class 2**

The heating turns off.

As soon as the inner chamber temperature has cooled down below the safety controller value, you can reset the alarm message on the controller. Press the **confirmation button**. The heating is then released and temperature control is resumed by the controller. The status LED "Heating active" is off.

If the safety controller class 2 has turned off the heating, we recommend proceeding as follows:

- Disconnect the chamber from the power supply.
- Have an expert examine and rectify the cause of the fault.
- Restart the chamber
- Reset the alarm message with the **confirmation button**

10. Timer functions

The chambers offer three timer functions:

"Delayed On", "Delayed Off", and "Temperature dependent Delayed Off".

10.1 Timer function "Delayed On"

This function serves to set a delay time until activating the control.

Following setting the timer run-time immediately starts running down.

While the timer run-time runs down, control is deactivated (standby mode), the heating and fan (with FD-S) are off.

When the timer expires the heating and fan (with FD-S) turn on. The temperature set-point is equilibrated.

10.1.1 Setting the timer run-time

Simultaneously press the **confirmation button** and the **arrow-down button** to access the “Advanced configuration” menu. The password entry display “A.Loc” flashes.

Enter the password “20” with the **arrow-up button** and confirm with the **confirmation button**.

Press the **arrow-up button** to access the “SPti” (timer functions) menu. Press the **confirmation button** to select the menu.

The “d_ti” (Delayed On) submenu is shown with the current setting.

Press the **confirmation button** to activate the entry. The display “d_ti” flashes.

Set the desired timer run-time with the **arrow buttons** and confirm with the **confirmation button**.

Keep pressed down the **confirmation button** and press the **arrow-up button** several times to return to Normal display.

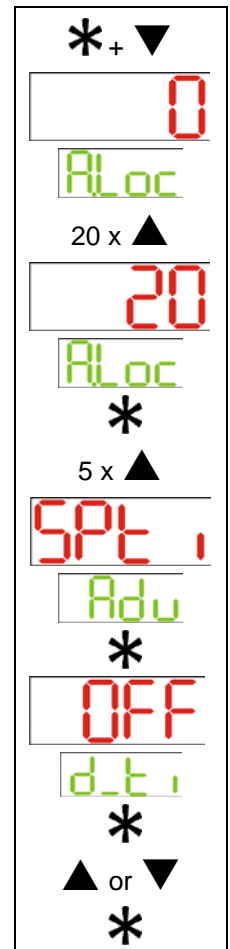

10.2 Timer function “Delayed Off”

This function serves to set a delay time until the control is turned off.

The selected timer run-time immediately starts running down.

When the timer expires, control deactivates (standby mode), heating and fan (with FD-S) turn off. The lower display in Normal display shows “OFF”.

10.2.1 Setting the timer run-time

In Normal display press the **arrow-down button** to access the “tOFF” entry menu.

The current timer run-time [hh.mm] is displayed (upper display)

Press the **confirmation button** to activate the entry. The display “tOFF” flashes.

Set the desired timer run-time with the **arrow buttons** and confirm with the **confirmation button**.

Press the **arrow-down button** to return to Normal display.

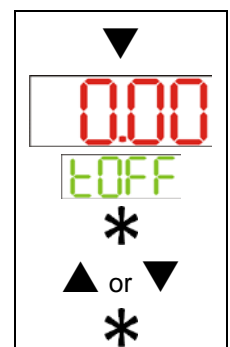

10.3 Timer function “Temperature dependent Delayed Off”

This function serves to set a delay time until the control is turned off, which takes effect when the set temperature set-point is reached.

The selected timer run-time only starts running down, when the actual value reached or exceeds the selected set-point.

When the timer expires the chamber reacts according to the selections made

Possible settings of the timer run-time:

- Setting the timer run-time [hh:mm] between 00:01 and 99:59. When the temperature set-point is reached, control remains active for the set duration. When the timer expires, control deactivates (standby mode). The lower display in Normal display shows “OFF”.
- Setting “OFF”: When the temperature set-point is reached, control deactivates immediately (standby mode), heating and fan (with FD-S) turn off. The lower display in Normal display shows “OFF”.
- Setting “inf” (infinite): Continuous operation. When the temperature set-point is reached, control remains in continuous operation.

10.3.1 Setting the timer run-time

Simultaneously press the **confirmation button** and the **arrow-down button** to access the “Advanced configuration” menu. The password entry display “A.Loc” flashes.

Enter the password “20” with the **arrow-up button** and confirm with the **confirmation button**.

Press the **arrow-up button** to access the “SPti” (timer functions) menu. Press the **confirmation button** to select the menu.

Press the **arrow-up button** twice to access the “O_ti” (Temperature dependent Delayed Off) submenu. The “O_ti” submenu is shown with the current setting.

Press the **confirmation button** to activate the entry. The display “O_ti” flashes.

Set the desired timer run-time or setting “inf” or “OFF” with the **arrow buttons** and confirm with the **confirmation button**.

Keep pressed down the **confirmation button** and press the **arrow-up button** several times to return to Normal display.

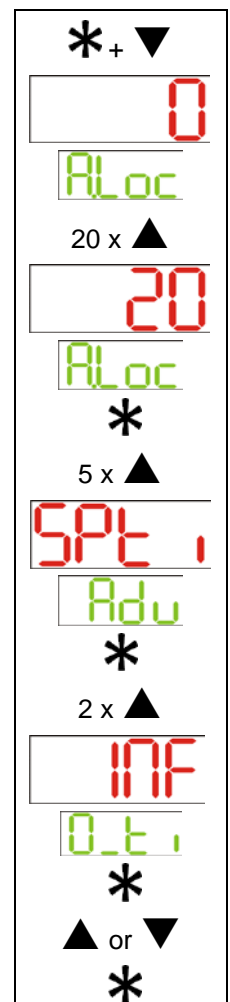

11. Ramp function

You can program temperature ramps in order to extend heating up times. This may be necessary in some cases to prevent temperature stress in the material during the heating up phase. Temperature ramps should only be used if required. Using them may result in considerably slowing down the heating up times. When the ramp function is turned off, the chamber will heat up with its maximum heating capacity.

The desired temperature rise is entered as a set-point gradient in degrees per hour. This gradient limits the maximum temperature increase to the entered value. Due to the heat and evaporation energy assumed by the drying material, smaller temperature gradients may also result.

You can select a gradient from "0.001" up to "9999" degrees per hour. The chamber will try to heat up according to the entered gradient. A heating-up rate of 24 °C per hour for the incubators BD-S and of 240 °C per hour for the heating and drying ovens ED-S and FD-S can be regarded as a realistic maximum.

The ramp proceeds from the actual value (equilibrated start set-point) towards the entered target set-point. During ramp operation the effective ramp set-point (SP_r) continually rises in accordance to the entered gradient from the start set-point to the target set-point. The actual value follows this continually changing effective ramp set-point. As soon as the entered target set-point (ramp target temperature) is reached, this value is maintained constant.

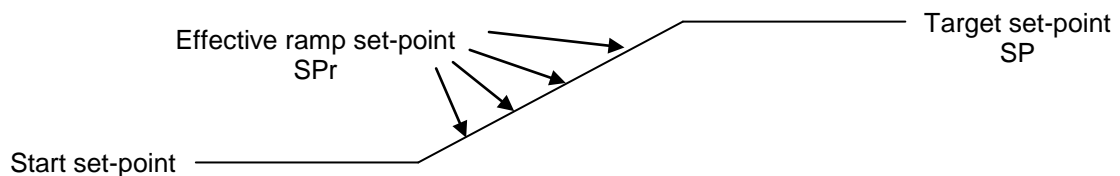

Figure 8: Set-point types during ramp operation

11.1 Setting the ramp

1. Enter the start set-point of the ramp (chap. 7) and let the temperature equilibrate to this value.
2. Set the desired gradient in the „rAtE“ menu
 - Setting „0.001“ up to „9999“: Maximum temperature rise in °C per hour or °F per hour.
 - Setting „Off“: deactivated ramp function. The chamber will heat up with its maximum heating capacity.
3. Then enter a new set-point as the ramp's target set-point (chap. 7).

As soon as the entries have been adopted, the ramp function is activated. The chamber heats up with the entered gradient, as long as the entered set-point (SP) exceeds the actual temperature value.

11.2 Setting the gradient

Simultaneously press the **confirmation button** and the **arrow-down button** to access the “Advanced configuration” menu. The password entry display “A.Loc” flashes.

Enter the password “20” with the **arrow-up button** and confirm with the **confirmation button**.

Press the **arrow-up button** to access the “SPti” (timer functions) menu. Press the **confirmation button** to select the menu.

Press the **arrow-up button** to access the “rAtE” (ramp gradient) submenu. The “rAtE” submenu is shown with the current setting.

Press the **confirmation button** to activate the entry. The display “rAtE” flashes.

Set the desired gradient with the **arrow buttons** and confirm with the **confirmation button**.

Keep pressed down the **confirmation button** and press the **arrow-up button** several times to return to Normal display.

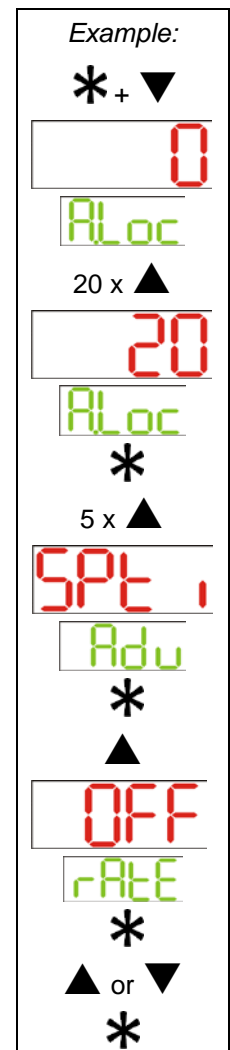

11.3 Display of the ramp course

In normal display the target set-point and the effective ramp set-point are shown alternately in the lower display.

11.4 Turning off the ramp function

To turn off the ramp function, the gradient must be set to “Off” in the “rAtE” menu (chap. 11.2).

12. Options

12.1 Data logger kits (option)

BINDER Data Logger Kits offer an independent long-term measuring system for temperature. They are equipped with a keyboard and a large LCD display, alarm functions and a real-time function. Measurement data are recorded in the Data Logger and can be read out after the measurement via the RS232 interface of the Data Logger. It offers a programmable measuring interval and permits storing up to 64000 measuring values. Reading out is done with the Data Logger evaluation software. You can give out a combined alarm and status protocol directly to a serial printer.

BD-S: Data Logger Kit T 220. Temperature range -90 °C / -130 °F up to +220 °C / 428 °F



ED-S, FD-S: Data Logger Kit T 350. Temperature range 0 °C / 32 °F up to +350 °C / 662 °F



For detailed information on installation and operation of the BINDER Data Logger, please refer to the mounting instructions Art. No. 7001-0204 and to the original user manual of the manufacturer, supplied with the data logger.

13. Maintenance, cleaning, and service

13.1 Maintenance intervals, service

 	 DANGER
	<p>Electrical hazard. Danger of death.</p> <ul style="list-style-type: none"> ⊘ The chamber must NOT become wet during operation or maintenance work. ⊘ Do NOT remove the rear panel of the chamber. ➤ Disconnect the chamber before conducting maintenance work. Disconnect the power plug. ➤ Ensure all maintenance work is conducted by licensed electricians or experts authorized by BINDER.

Ensure regular maintenance work is performed at least once a year.



The warranty becomes void if maintenance work is conducted by non-authorized personnel..



Replace the door gasket only when cold. Otherwise, the door gasket may become damaged.





We recommend taking out a maintenance agreement. Please consult BINDER Service.

BINDER telephone hotline:	+49 (0) 7462 2005 555
BINDER fax hotline:	+49 (0) 7462 2005 93555
BINDER e-mail hotline:	service@binder-world.com
BINDER service hotline USA:	+1 866 885 9794 or +1 631 224 4340 x3 (toll-free in the USA)
BINDER service hotline Asia Pacific:	+852 390 705 04 or +852 390 705 03
BINDER service hotline Russia and CIS	+7 495 988 15 16
BINDER Internet website	http://www.binder-world.com
BINDER address	BINDER GmbH, post office box 102, D-78502 Tuttlingen

International customers, please contact your local BINDER distributor.

13.2 Cleaning and decontamination

Clean the chamber after each use to avoid potential corrosion damage by ingredients of the test material.

  	 DANGER
	<p>Electrical hazard. Danger of death.</p> <ul style="list-style-type: none"> ∅ Do NOT spill water or cleaning agents over the inner and outer surfaces. ➤ Disconnect the chamber before cleaning. Disconnect the power plug. ➤ Completely dry the chamber before turning it on again.

13.2.1 Cleaning

Disconnect the chamber from the power supply before cleaning. Disconnect the power plug.

	The interior of the chamber must be kept clean. Thoroughly remove any residues of the charging material
---	---

Wipe the surfaces with a moistened towel. In addition, you can use the following cleaning agents:

Exterior surfaces inner chamber racks door gaskets	Standard commercial cleaning detergents free from acid or halides. Alcohol-based solutions. We recommend using the neutral cleaning agent Art. No. 1002-0016.
Instrument panel	Standard commercial cleaning detergents free from acid or halides. We recommend using the neutral cleaning agent Art. No. 1002-0016.
Zinc coated hinge parts rear chamber wall	Standard commercial cleaning detergents free from acid or halides. Do NOT use a neutral cleaning agent on zinc coated surfaces.

Do not use cleaning agents that may cause a hazard due to reaction with components of the device or the charging material. If there is doubt regarding the suitability of cleaning products, please contact BINDER service.

	<p>We recommend using the neutral cleaning agent Art. No. 1002-0016 for a thorough cleaning. Any corrosive damage that may arise following use of other cleaning agents is excluded from liability by BINDER GmbH.</p> <p>Any corrosive damage caused by a lack of cleaning, is excluded from liability by BINDER GmbH.</p>
---	---

	CAUTION
	<p>Danger of corrosion. Damage to the chamber.</p> <ul style="list-style-type: none"> ∅ Do NOT use acidic or chlorine cleaning detergents. ∅ Do NOT use a neutral cleaning agent on other kind of surfaces e.g., the zinc coated hinge parts or the rear chamber wall.

	<p>For surface protection, perform cleaning as quickly as possible.</p> <p>After cleaning completely remove cleaning agents from the surfaces with a moistened towel. Let the chamber dry.</p>
---	--



	Soapsuds may contain chlorides and must therefore NOT be used for cleaning.
---	---

	With every decontamination method, always use adequate personal safety controls.
---	--

Following cleaning, leave the chamber door open or remove the access port plugs.

	The neutral cleaning agent may cause health problems in contact with skin and if ingested. Follow the operating instructions and safety hints labeled on the bottle of the neutral cleaning agent.
---	--

Recommended precautions: To protect the eyes use sealed protective goggles. Suitable protective gloves with full contact: butyl or nitrile rubber, penetration time >480 minutes.

	 CAUTION
	<p>Contact with skin, ingestion. Skin and eye damage due to chemical burns.</p> <ul style="list-style-type: none"> Ø Do not ingest. Keep away from food and beverages. Ø Do NOT empty into drains. ➤ Wear protective gloves and goggles. ➤ Avoid skin contact.

13.2.2 Decontamination

The operator must ensure that proper decontamination is performed in case a contamination of the chamber by hazardous substances has occurred.

Disconnect the chamber from the power supply prior to decontamination. Pull the power plug.

Do not use decontamination agents that may cause a hazard due to reaction with components of the device or the charging material. If there is doubt regarding the suitability of cleaning products, please contact BINDER service.

You can use the following disinfectants:

Inner chamber	Standard commercial surface disinfectants free from acid or halides. Alcohol-based solutions. We recommend using the disinfectant spray Art. No. 1002-0022.
---------------	---

	For chemical disinfection, we recommend using the disinfectant spray Art. No. 1002-0022. Any corrosive damage that may arise following use of other disinfectants is excluded from liability by BINDER GmbH.
---	--

	With every decontamination method, always use adequate personal safety controls.
---	--

In case of impurity of the interior with biological or chemical hazardous material, there are three possible procedures depending on the type of contamination and of the charging material.

1. The drying and heating ovens ED-S and FD-S can be hot air sterilized at 190 °C / 374 °F for at least 30 minutes. All inflammable goods must be removed from the interior before.





2. Spray the inner chamber with an appropriate disinfectant.

Before start-up, the chamber must be absolute dry and ventilated, because explosive gases may form during the decontamination process.

3. You can remove the racks and the rack supports from the chamber and sterilize them

	<p>In case of eye contact, the disinfectant spray may cause eye damage due to chemical burns. Follow the operating instructions and safety hints labeled on the bottle of the disinfectant spray.</p>
---	---

Recommended precautions: To protect the eyes use sealed protective goggles.

	<table border="1"> <tr> <td data-bbox="534 560 1468 638" style="background-color: yellow;">  CAUTION </td> </tr> <tr> <td data-bbox="534 638 1468 842"> <p>Eye contact. Eye damage due to chemical burns.</p> <ul style="list-style-type: none"> ⊘ Do NOT empty into drains. ➤ Wear protective goggles. </td> </tr> </table>	 CAUTION	<p>Eye contact. Eye damage due to chemical burns.</p> <ul style="list-style-type: none"> ⊘ Do NOT empty into drains. ➤ Wear protective goggles.
 CAUTION			
<p>Eye contact. Eye damage due to chemical burns.</p> <ul style="list-style-type: none"> ⊘ Do NOT empty into drains. ➤ Wear protective goggles. 			

	<p>After using the disinfectant spray, allow the chamber to dry thoroughly, and aerate it sufficiently.</p>
---	---

13.3 Sending the chamber back to BINDER GmbH

If you return a BINDER product to us for repair or any other reason, we will only accept the product upon presentation of an **authorization number** (RMA number) that has previously been issued to you. An authorization number will be issued after receiving your complaint either in writing or by telephone **prior** to your sending the BINDER product back to us. The authorization number will be issued following receipt of the information below:

- BINDER product type and serial number
- Date of purchase
- Name and address of the dealer from which you bought the BINDER product
- Exact description of the defect or fault
- Complete address, contact person and availability of that person
- Exact location of the BINDER product in your facility
- A contamination clearance certificate (chap. 19) must be faxed in advance

The authorization number must be applied to the packaging in such a way that it can be easily recognized or be recorded clearly in the delivery documents.

	<p>For safety reasons we cannot accept a chamber delivery if it does not carry an authorization number.</p>
---	---

Return address: BINDER GmbH, Abteilung Service
 Gänsäcker 16, 78502 Tuttlingen, Germany

14. Disposal

14.1 Disposal of the transport packing

Packing element	Material	Disposal
Straps to fix packing on pallet	Plastic	Plastic recycling
Wooden transport box (option)	Non-wood (compressed match-wood, IPPC standard)	Wood recycling
with metal screws	Metal	Metal recycling
Pallet (size 115)	Solid wood (IPPC standard)	Wood recycling
Transport box with metal clamps	Cardboard	Paper recycling
	Metal	Metal recycling
Edge protection	Styropor [®] or PE foam	Plastic recycling
Protection of doors and racks	PE foam	Plastic recycling
Bag for operating manual	PE foil	Plastic recycling
Insulating air cushion foil (packing of optional accessories)	PE foil	Plastic recycling

If recycling is not possible, all packing parts can also be disposed of with normal waste.

14.2 Decommissioning

- Disconnect the chamber from the power supply (pull the power plug).
- Temporal decommissioning: See indications for appropriate storage, chap. 3.3.
- Final decommissioning: Dispose of the chamber as described in chap. 14.3 to 14.5.

14.3 Disposal of the chamber in the Federal Republic of Germany

According to Annex I of Directive 2012/19/EU of the European Parliament and of the Council on waste electrical and electronic equipment (WEEE), BINDER devices are classified as “monitoring and control instruments” (category 9) only intended for professional use“. They must not be disposed of at public collecting points.

The chambers bear the symbol for the marking of electrical and electronic equipment manufactured / placed on the market in the EC after 13 August 2005 and be disposed of in separate collection according to Directive 2012/19/EU on waste electrical and electronic equipment (WEEE) and German national law for electrical and electronic equipment (Elektro- und Elektronikgerätegesetz, ElektroG). WEEE marking: crossed-out wheeled bin with solid bar under. A significant part of the materials must be recycled in order to protect the environment.

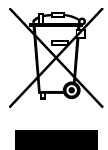



At the end of the device's service life, have the device disposed of according to the German national law for electrical and electronic equipment (Elektro- und Elektronikgerätegesetz, ElektroG from 20 October 2015, BGBl. I p. 1739) or contact BINDER service who will organize taking back and disposal of the chamber according to the German national law for electrical and electronic equipment (Elektro- und Elektronikgerätegesetz, ElektroG from 20 October 2015, BGBl. I p. 1739).

	CAUTION
	<p>Violation against existing law.</p> <ul style="list-style-type: none"> ∅ Do NOT dispose of BINDER devices at public collecting points. ➤ Have the device disposed of professionally at a recycling company which is certified according to the German national law for electrical and electronic equipment (Elektro- und Elektronikgerätegesetz, ElektroG from 20 October 2015, BGBl. I p. 1739). <li style="text-align: center;"><i>or</i> ➤ Instruct BINDER Service to dispose of the device. The general terms of payment and delivery of BINDER GmbH apply, which were valid at the time of purchasing the chamber.

Certified companies disassemble waste BINDER equipment in primary substances for recycling according to Directive 2012/19/EU. In order to eliminate any health hazards to the employees of the recycling companies, the devices must be free from toxic, infectious or radioactive substances.

	<p>Prior to handing the chamber over to a recycling company, it is the user's responsibility that it is free from toxic, infectious or radioactive substances.</p> <ul style="list-style-type: none"> • Prior to disposal, clean all introduced or residual toxic substances from the chamber. • Prior to disposal, disinfect the chamber from all sources of infection. Be aware of the fact that sources of infection may also be located outside the inner chamber. • If you cannot safely remove all toxic substances and sources of infection from the chamber, dispose of it as "special" waste according to national law. • Fill out the contamination clearance certificate (chap. 19) and enclose it with the chamber.
---	---

	 WARNING
	<p>Contamination of the device with toxic, infectious or radioactive substances.</p> <p>Danger of intoxication.</p> <p>Danger of infection.</p> <ul style="list-style-type: none"> ∅ NEVER take a chamber contaminated with toxic substances or sources of infection for recycling according to Directive 2012/19/EU. ➤ Prior to disposal, remove all toxic substances and sources of infection from the chamber. ➤ Dispose of a chamber from which all toxic substances or sources of infection cannot be safely removed as special waste according to national law.

14.4 Disposal of the chamber in the member states of the EU except for the Federal Republic of Germany

According to Annex I of Directive 2012/19/EU of the European Parliament and of the Council on waste electrical and electronic equipment (WEEE), BINDER devices are classified as "monitoring and control instruments" (category 9) only intended for professional use". They must not be disposed of at public collecting points.

The chambers bear the symbol for the marking of electrical and electronic equipment manufactured / placed on the market in the EC after 13 August 2005 and be disposed of in separate collection according to the Directive 2012/19/EU on waste electrical and electronic equipment (WEEE). WEEE marking: crossed-out wheeled bin with solid bar under.





At the end of the device's service life, notify the distributor who sold you the device, who will take back and dispose of the chamber according to the Directive 2012/19/EU on waste electrical and electronic equipment (WEEE).

	CAUTION
	<p>Violation against existing law.</p> <ul style="list-style-type: none"> ⊘ Do NOT dispose of BINDER devices at public collecting points. ➤ Have the device disposed of professionally at a recycling company which is certified according to conversion of the Directive 2012/19/EU into national law. <li style="padding-left: 20px;"><i>or</i> ➤ Instruct the distributor who sold you the device to dispose of it. The agreements apply that were reached with the distributor when purchasing the chamber (e.g. his general terms of payment and delivery). ➤ If your distributor is not able to take back and dispose of the chamber, please contact BINDER service.

Certified companies disassemble waste BINDER equipment in primary substances for recycling according to Directive 2012/19/EU. In order to exclude any health hazard for the employees of the recycling companies, the devices must be free from toxic, infectious or radioactive substances.

	<p>Prior to handing the chamber over to a recycling company, it is the user's responsibility that it is free from toxic, infectious or radioactive substances.</p> <ul style="list-style-type: none"> • Prior to disposal, clean all introduced or residual toxic substances from the chamber. • Prior to disposal, disinfect the chamber from all sources of infection. Be aware of the fact that sources of infection may also be located outside the inner chamber. • If you cannot safely remove all sources of infection and toxic substances from the chamber, dispose of it as "special" waste according to national law. • Fill out the contamination clearance certificate (chap. 19) and enclose it with the chamber.
---	---

	 WARNING
	<p>Contamination of the device with toxic, infectious or radioactive substances. Danger of intoxication. Danger of infection.</p> <ul style="list-style-type: none"> ⊘ NEVER take a chamber contaminated with toxic substances or sources of infection for recycling according to Directive 2012/19/EU. ➤ Prior to disposal, remove all toxic substances and sources of infection from the chamber. ➤ Dispose of a chamber from which all toxic substances or sources of infection cannot be safely removed as "special" waste according to national law.

14.5 Disposal of the chamber in non-member states of the EU

	CAUTION
	<p>Alteration of the environment.</p> <ul style="list-style-type: none"> ➤ For final decommissioning and disposal of the chamber, please contact BINDER Service. ➤ Follow the statutory regulations for appropriate, environmentally friendly disposal.

15. Troubleshooting

Fault description	Possible cause	Required measures
Chamber without function. Controller display is dark.	No power supply.	Check connection to power supply.
	Overtemperature protective device class 1 has turned off the chamber.	Contact BINDER service.
	Controller defective.	Contact BINDER service.
Chamber without function. Controller shows "OFF" on lower display and actual temperature value on upper display.	Chamber in standby mode.	Press the confirmation button .
Set-point temperature is not reached after specified time.	Chamber door not properly closed.	Completely close chamber door.
	Door gasket defective.	Replace door gasket,
	Controller not adjusted.	Calibrate and adjust controller.
	Wrong voltage.	Check the power supply for correct voltage (chap. 4.2).
<i>FD-S</i> : The fan doesn't turn or turns too slowly.	Fan defective.	Contact BINDER service.
Chamber heating permanently, set-point not held.	Controller defective.	Contact BINDER service.
	Pt 100 sensor defective.	
	Semiconductor relay defective	
	Controller not adjusted.	Calibrate and adjust controller.
Chamber doesn't heat up. Status LED "Heating active" is lit.	Heating element defective.	Contact BINDER service.
	Semiconductor relay defective.	
Chamber doesn't heat up. Status LED "Heating active" is not lit. Controller display working.	Timer run off.	Re-program the timer or turn it off.
	Semiconductor relay defective.	Contact BINDER service.
	Controller defective.	
Chamber doesn't heat up. Status LED "Safety controller active" is lit.	<i>BD-S</i> : Safety controller class 3.1 has responded.	Check the settings of the temperature set-point and of the safety controller. If appropriate, select suitable limit value. See chap. 9.2.
	<i>ED-S, FD-S</i> : Safety controller class 2 has turned off the heating.	Let cool down the chamber. Press the confirmation button (chap. 9.2.2). Check the settings of the temperature set-point and of the safety controller. If appropriate, select suitable limit value.
	Safety controller defective.	Contact BINDER service.
Deviations from the indicated heating-up times.	Chamber fully loaded.	Load the chamber less or consider longer heating-up times.
Controller shows "OFF" on lower display and "OPEN" on upper display.	Sensor rupture between sensor and controller.	Contact BINDER service.



Only qualified service personnel authorized by BINDER must perform repair. Repaired chambers must comply with the BINDER quality standards.

16. Technical description

16.1 Factory calibration and adjustment

This chamber was calibrated and adjusted in the factory. Calibration and adjustment were performed using standardized test instructions, according to the QM DIN EN ISO 9001 system applied by BINDER (certified since December 1996 by TÜV CERT). All test equipment used is subject to the administration of measurement and test equipment that is also constituent part of the BINDER QM DIN EN ISO 9001 systems. They are controlled and calibrated to a DKD-Standard at regular intervals.

16.2 Definition of usable volume

The usable volume illustrated below is calculated as follows:

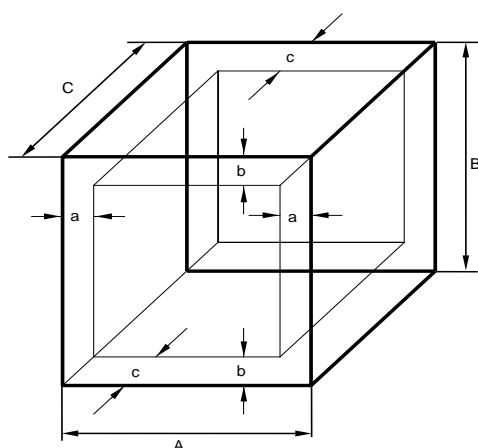

A, B, C = Internal dimensions (W, H, D)
a, b, c = Wall clearances

$$a = 0.1 \times A$$

$$b = 0.1 \times B$$

$$c = 0.1 \times C$$

$$V_{\text{USE}} = (A - 2a) \times (B - 2b) \times (C - 2c)$$

Figure 9: Determination of the useable volume

The technical data refers to the defined usable volume.



Do NOT place samples outside this usable volume.
Do NOT load this volume by more than half to enable sufficient airflow inside the chamber.
Do NOT divide the usable volume into separate parts with large area samples.
Do NOT place samples too close to each other in order to permit circulation between them and thus obtain a homogenous distribution of temperature.

16.3 Over current protection

The chambers are protected by one (UL chambers) or two miniature fuses against over current, accessible from the outside. The miniature fuses are located at the rear of the chamber above the power cable connection. Each fuse holder is equipped with a fuse clip 5mm x 20 mm (cUL-Version 6,3x32 mm). A fuse may be replaced only with a substitute of the same ratings. Refer to the technical data of the respective device type.

16.4 Technical data

Model		BD-S	ED-S	FD-S	BD-S	ED-S	FD-S	
Chamber size		56	56	56	115	115	115	
Exterior dimensions								
Width, net	mm / inch	595 / 23.43	595 / 23.43	595 / 23.43	745 / 29.33	745 / 29.33	745 / 29.33	
Height, gross (incl. feet)	mm / inch	625 / 24.60	625 / 24.60	625 / 24.60	735 / 28.94	735 / 28.94	735 / 28.94	
Depth, net	mm / inch	525 / 20.67	525 / 20.67	525 / 20.67	565 / 22.24	565 / 22.24	565 / 22.24	
Depth, gross (incl. door handle)	mm / inch	580 / 22.83	580 / 22.83	580 / 22.83	620 / 24.41	620 / 24.41	620 / 24.41	
Wall clearance rear (minimum)	mm / inch	160 / 6.30	160 / 6.30	160 / 6.30	160 / 6.30	160 / 6.30	160 / 6.30	
Wall clearance side (minimum)	mm / inch	100 / 3.94	100 / 3.94	100 / 3.94	100 / 3.94	100 / 3.94	100 / 3.94	
Spacing above the chamber	mm / inch	160 / 6.30	160 / 6.30	160 / 6.30	160 / 6.30	160 / 6.30	160 / 6.30	
Exhaust air outlet, inner diameter	mm / inch	50 / 1.97	50 / 1.97	50 / 1.97	50 / 1.97	50 / 1.97	50 / 1.97	
Doors								
Number of doors		1	1	1	1	1	1	
Number of inner glass doors		1	--	--	1	--	--	
Interior dimensions								
Width	mm / inch	400 / 15.75	400 / 15.75	400 / 15.75	550 / 21.65	550 / 21.65	550 / 21.65	
Height	mm / inch	440 / 17.32	440 / 17.32	440 / 17.32	550 / 21.65	550 / 21.65	550 / 21.65	
Depth	mm / inch	350 / 13.78	350 / 13.78	310 / 12.20	390 / 15.35	390 / 15.35	350 / 13.78	
Interior volume	l / cu.ft.	62 / 2.19	62 / 2.19	55 / 1.94	118 / 4.17	118 / 4.17	106 / 3.74	
Steam space volume	l / cu.ft.	62 / 2.19	62 / 2.19	62 / 2.19	118 / 4.17	118 / 4.17	118 / 4.17	
Racks								
Quantity of racks (regular)		1	1	1	1	1	1	
Quantity of racks (max.)		3	3	3	5	5	5	
Max. load per rack	Kg / lbs	15 / 33	15 / 33	15 / 33	20 / 44	20 / 44	20 / 44	
Permitted total load	Kg / lbs	30 / 66	30 / 66	30 / 66	75 / 165	75 / 165	75 / 165	
Weight								
Weight (empty)	Kg / lbs	38 / 84	39 / 86	39 / 86	54 / 119	54 / 119	54 / 119	
Temperature data								
Temperature range	from ... degrees above ambient	°C / °F	5 / 9	10 / 18	10 / 18	5 / 9	10 / 18	10 / 18
	up to	°C / °F	70 / 158	250 / 482	250 / 482	70 / 158	250 / 482	250 / 482
Temperature fluctuation at 37 °C / 98.6 °F		+/- K	0.1	--	--	0.2	--	--
Temperature fluctuation at 150 °C / 302 °F		+/- K	--	0.8	0.5	--	0.8	0.5
Temperature uniformity (variation) at 37 °C / 98.6 °F		+/- K	0.7	--	--	0.5	--	--
Temperature uniformity (variation) at 150 °C / 302 °F		+/- K	--	2.8	2.6	--	2.8	2.4

Model		BD-S	ED-S	FD-S	BD-S	ED-S	FD-S
Chamber size		56	56	56	115	115	115
Temperature data (continued)							
Heating up time to 150 °C / 302 °F	minutes	--	60	20	--	55	22
Recovery time after door was opened for 30 sec at 37 °C / 98.6 °F	minutes	15	--	--	15	--	--
Recovery time after door was opened for 30 sec at 150 °C / 302 °F	minutes	--	--	7	--	--	8
Ventilation data							
Air change	x/h	--	--	80	--	--	32
Electrical data (model versions BD-S056-230V, BD-S115-230V, ED-S056-230V, ED-S115-230V, FD-S056-230V, FD-S115-230V)							
System of housing protection acc. to EN 60529	IP	20	20	20	20	20	20
Nominal voltage (+/-10%) at 50 Hz power frequency	V	230	230	230	230	230	230
Nominal voltage (+/-10%) at 60 Hz power frequency	V	230	230	230	230	230	230
Current type		1N~	1N~	1N~	1N~	1N~	1N~
Nominal power	kW	0,30	1,05	1,10	0,35	1,25	1,30
Power plug of the power cable		Grounded plug					
Chamber fuse (external) 5x20 mm / 250V / time-lag (T)	A	6,3	6,3	6,3	6,3	6,3	6,3
Overtemperature protective device class 1	°C / °F	90 / 194	318 / 604.4	318 / 604.4	90 / 194	318 / 604.4	318 / 604.4
Installation category acc. to IEC 61010-1		II	II	II	II	II	II
Pollution degree acc. to IEC 61010-1		2	2	2	2	2	2
Different electrical data for chambers constructed for the USA and Canada (model versions BD-S056UL-120V, BD-S115UL-120V, ED-S056UL-120V, ED-S115UL-120V, FD-S056UL-120V, FD-S115UL-120V)							
Nominal voltage (+/-10%) at 50 Hz power frequency	V	120	120	120	120	120	120
Nominal voltage (+/-10%) at 60 Hz power frequency	V	120	120	120	120	120	120
Nominal power	kW	0,30	1,15	1,20	0,35	1,35	1,40
Power plug of the power cable	NEMA	5-15P	5-15P	5-15P	5-15P	5-15P	5-15P
Chamber fuse (external) 5x20 mm / 250V / time-lag (T)	A	12,5	12,5	12,5	12,5	12,5	12,5
Environment-specific data							
Noise level (mean value)	dB (A)	--	--	43	--	--	43
Energy consumption at 37 °C / 98.6 °F	Wh/h	25	--	--	25	--	--
Energy consumption at 150 °C / 302 °F	Wh/h	--	180	290	--	310	340

All technical data is specified for unloaded chambers with standard equipment at an ambient temperature of +22 °C +/- 3°C / 71.6 °F +/- 5.4 °F and a power supply voltage fluctuation of +/-10%. Technical data is determined in accordance to BINDER Factory Standard Part 2:2015 and DIN 12880:2007.

All indications are average values, typical for chambers produced in series. We reserve the right to change technical specifications at any time.



If the chamber is fully loaded, the specified heating up times may vary according to the load.

16.5 Equipment and options (extract)



To operate the chamber, use only original BINDER accessories or accessories / components from third-party suppliers authorized by BINDER. The user is responsible for any risk arising from using unauthorized accessories.

Standard equipment

R-S microprocessor temperature controller

3 timer functions: "Delayed On", "Delayed Off", and "Temperature dependent delayed Off"

Adjustable ramp function

BD-S: Temperature safety controller class 3.1 acc. to DIN 12880:2007 with visual alarm

ED-S, FD-S: Temperature safety controller class 2 acc. to DIN 12880:2007 with visual alarm

BD-S: Inner glass door

Exhaust air outlet, internal diameter 50 mm / 1.97 inches, with exhaust air flap

Adjustable air change via exhaust air outlet

2 racks, chrome-plated, each rack with 4 rack supports

Options / accessories

Rack, chrome-plated

Data Logger Kit T 220

Data Logger Kit T 350

Neutral cleaning agent (liquid concentrate)

Stable table on wheels with castors and locking brakes

16.6 Accessories and spare parts (extract)



BINDER GmbH is responsible for the safety features of the chamber only, provided skilled electricians or qualified personnel authorized by BINDER perform all maintenance and repair, and if components relating to chamber safety are replaced in the event of failure with original spare parts. The user is responsible for any risks arising from using unauthorized accessories/components.

Chamber size	56	115
Description	Art. No.	
Rack, chrome-plated	6004-0209	6004-0210
Door gasket, silicone	6005-0287	6005-0288
Stable table on wheels with castors and locking brakes	9051-0005	
Chamber fuse 5x20mm 250V 6,3 A time lag (T)	5006-0092	
Chamber fuse 5x20mm 250V 12,5 A time lag (T) for UL chambers	5006-0096	
4 rack supports	8012-1879	
Data Logger kit T 220	8012-0715	
Data Logger kit T 350	8012-0714	
Data Logger software	8012-0821	
Neutral cleaning agent, 1 kg	1002-0016	

For information on components not listed here, please contact BINDER Service.

16.7 Dimensioned drawings

16.7.1 BD-S 56

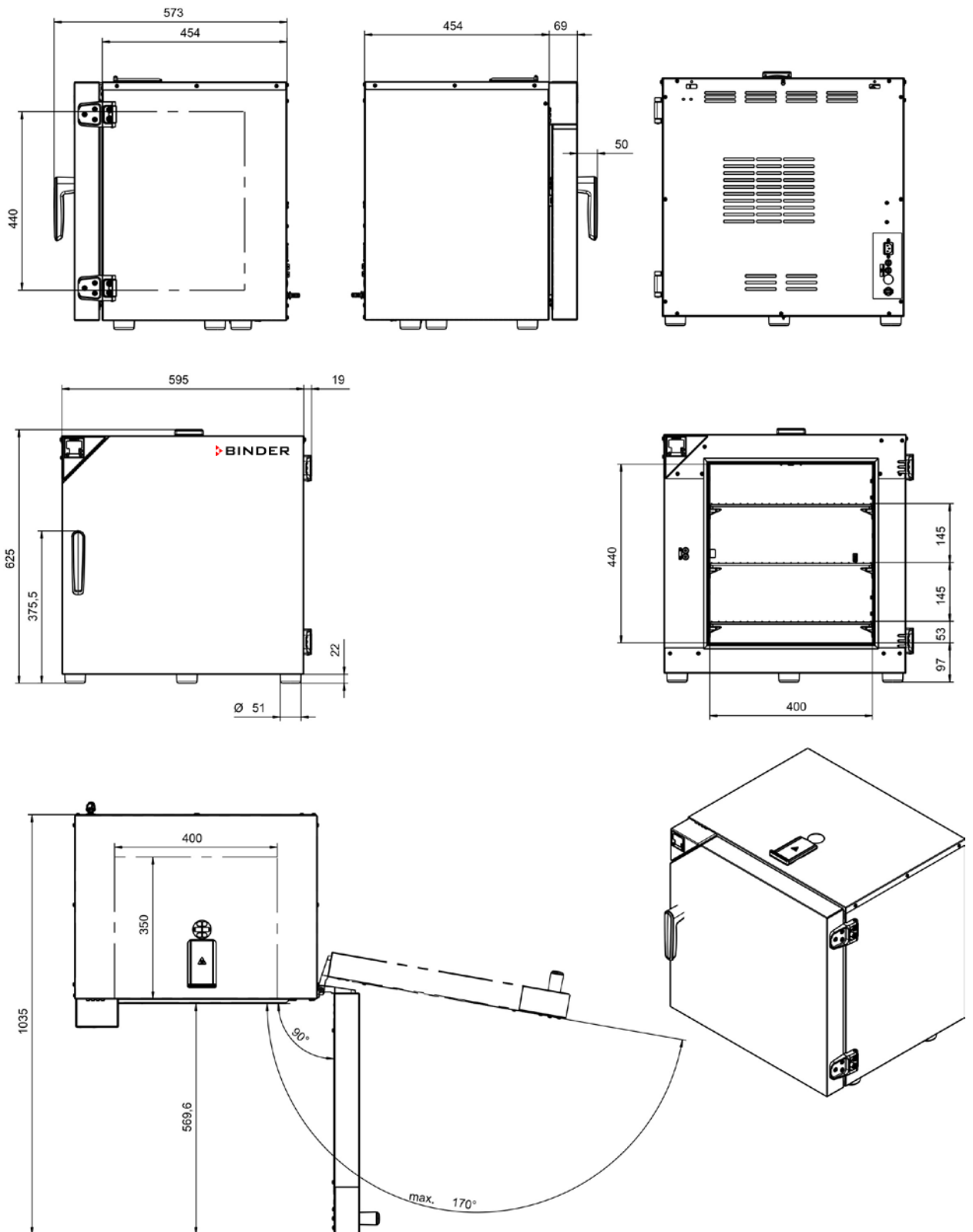

[mm]

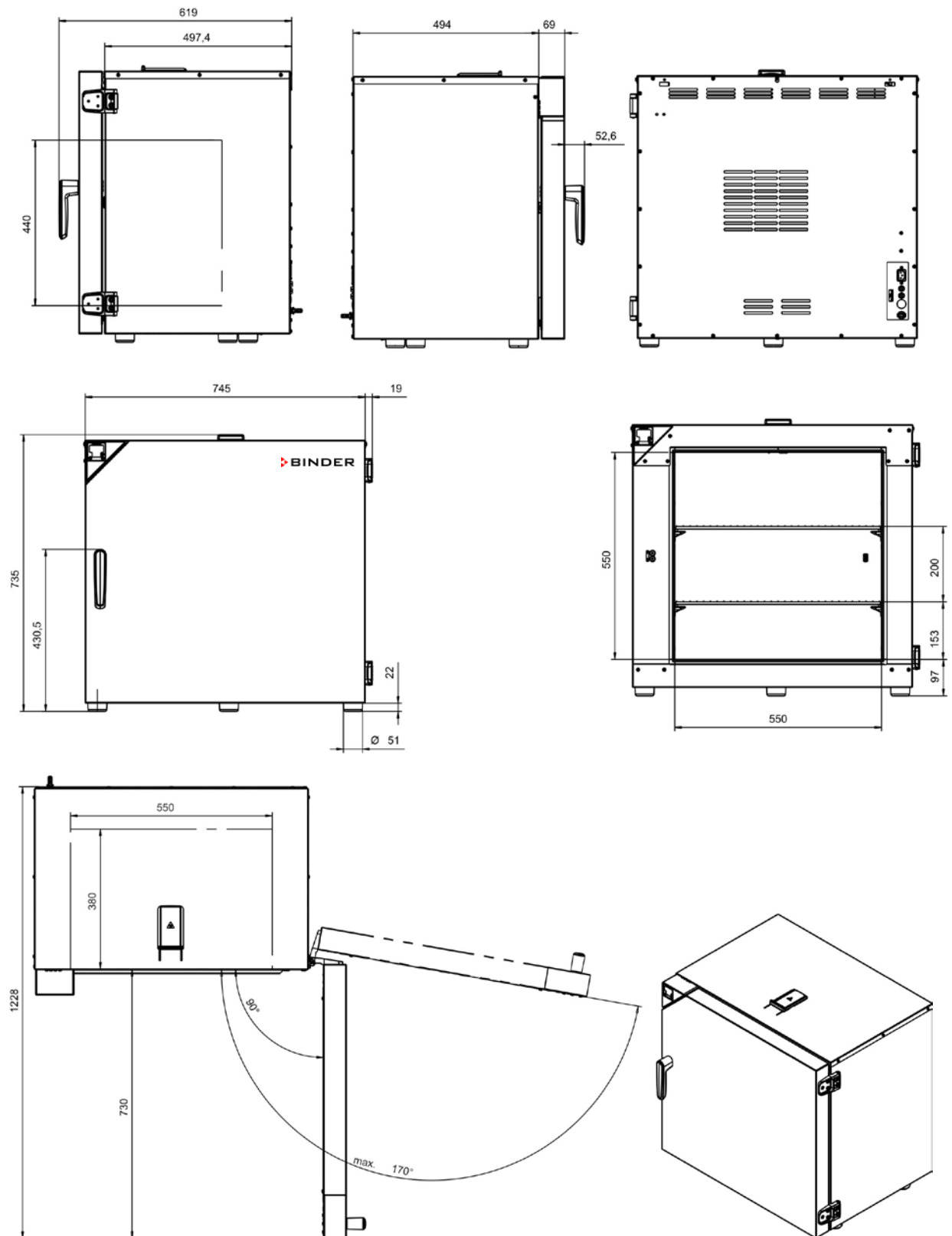
16.7.2 BD-S 115

[mm]

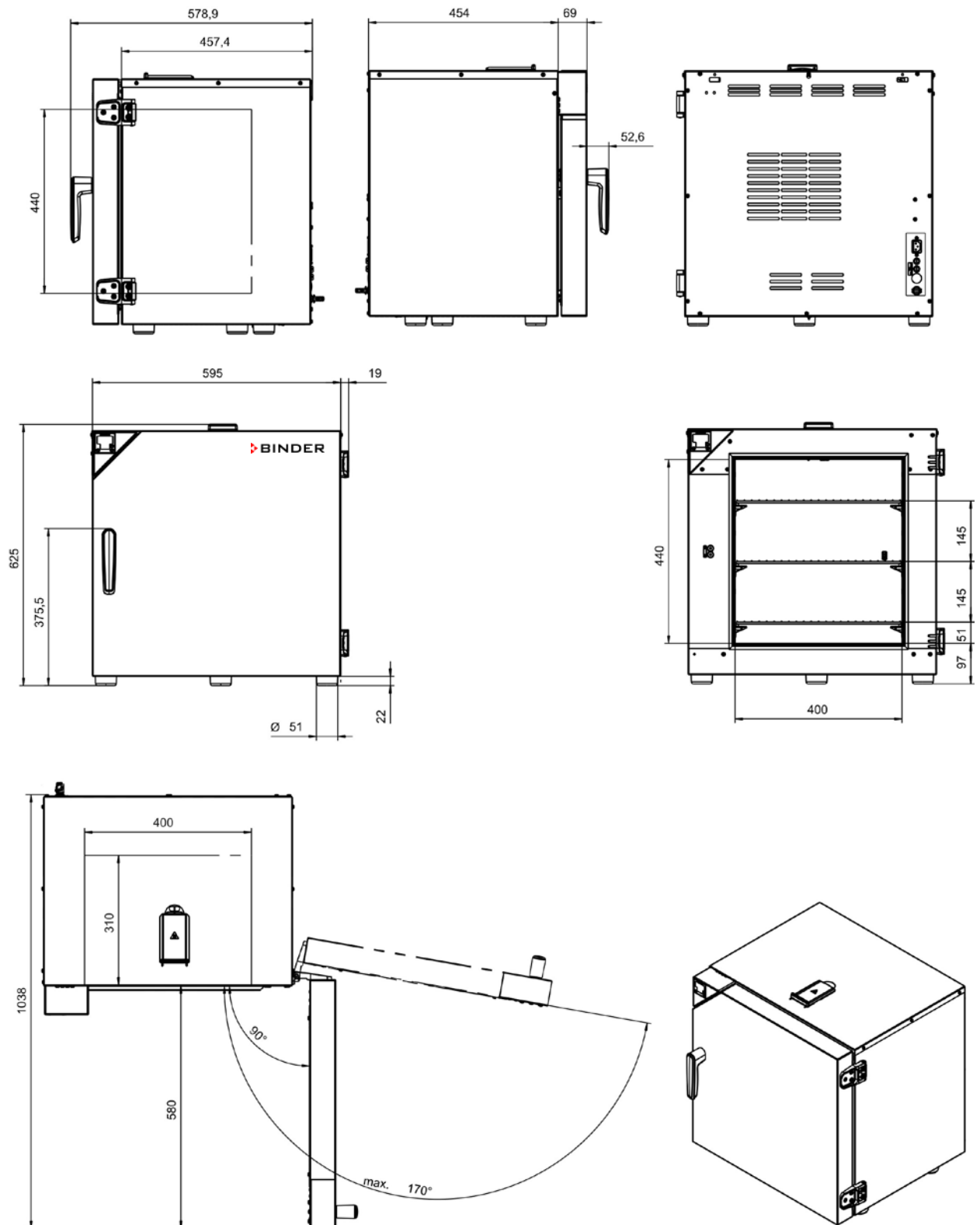
16.7.3 ED-S 56

[mm]

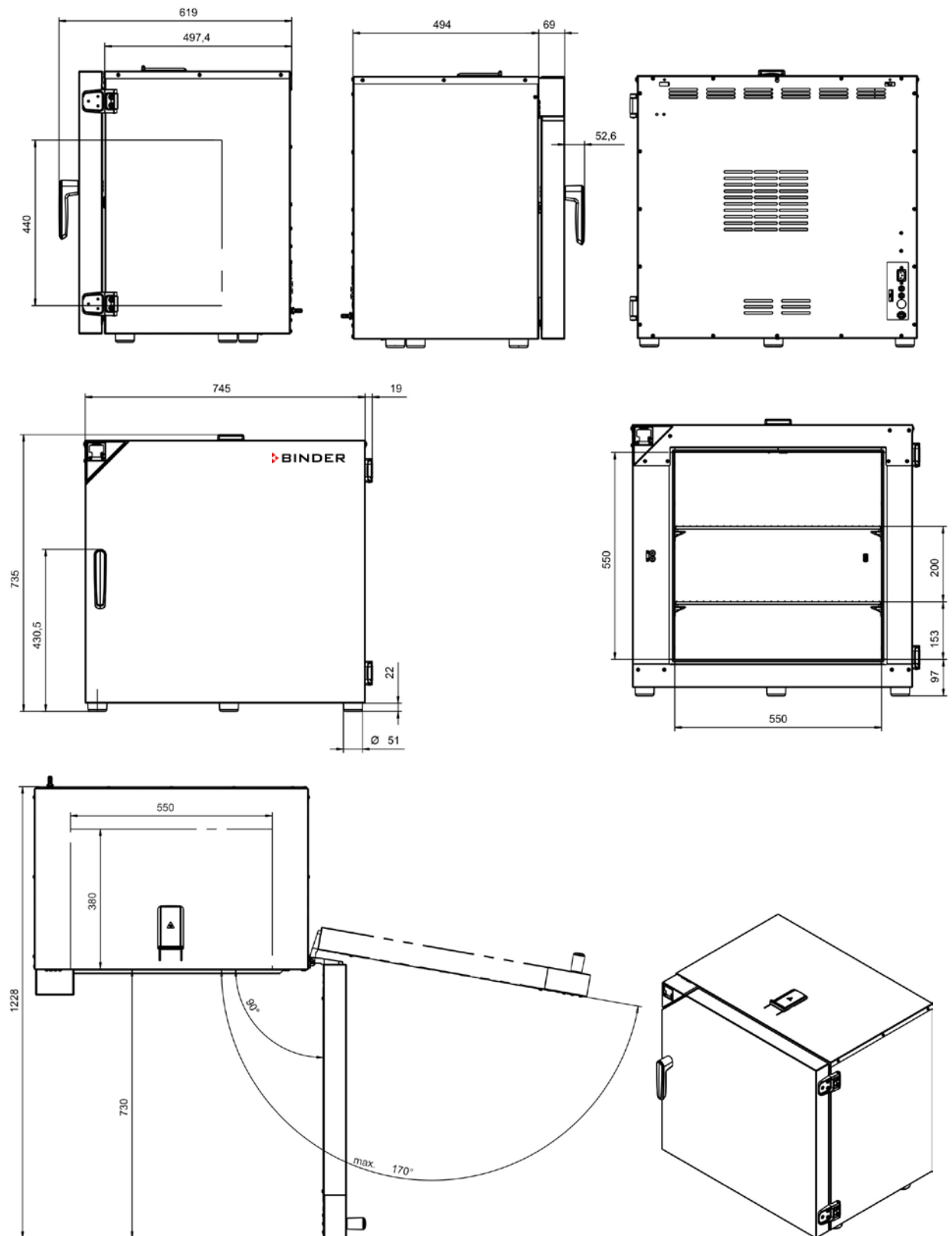
16.7.4 ED-S 115

[mm]

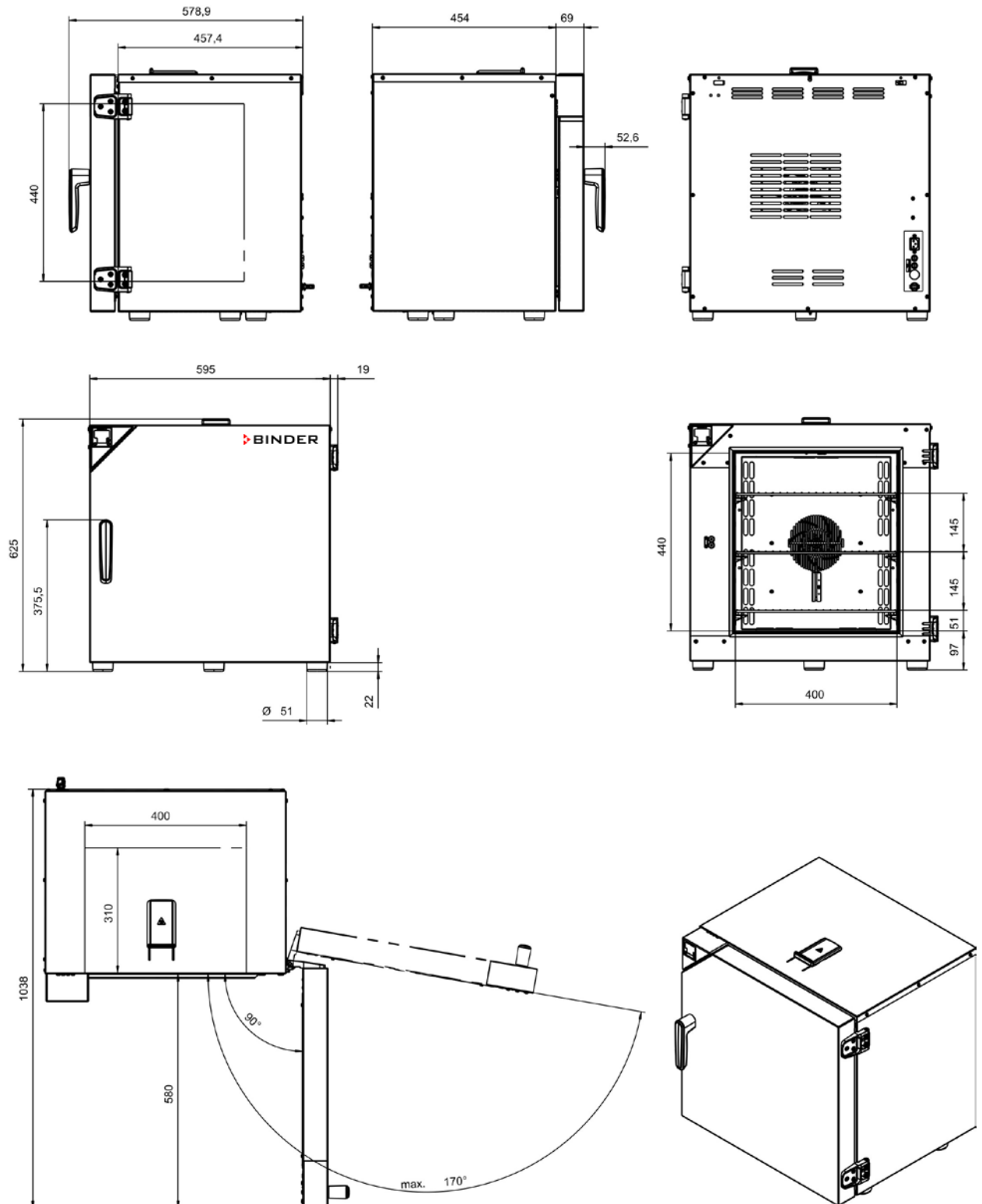
16.7.5 FD-S 56

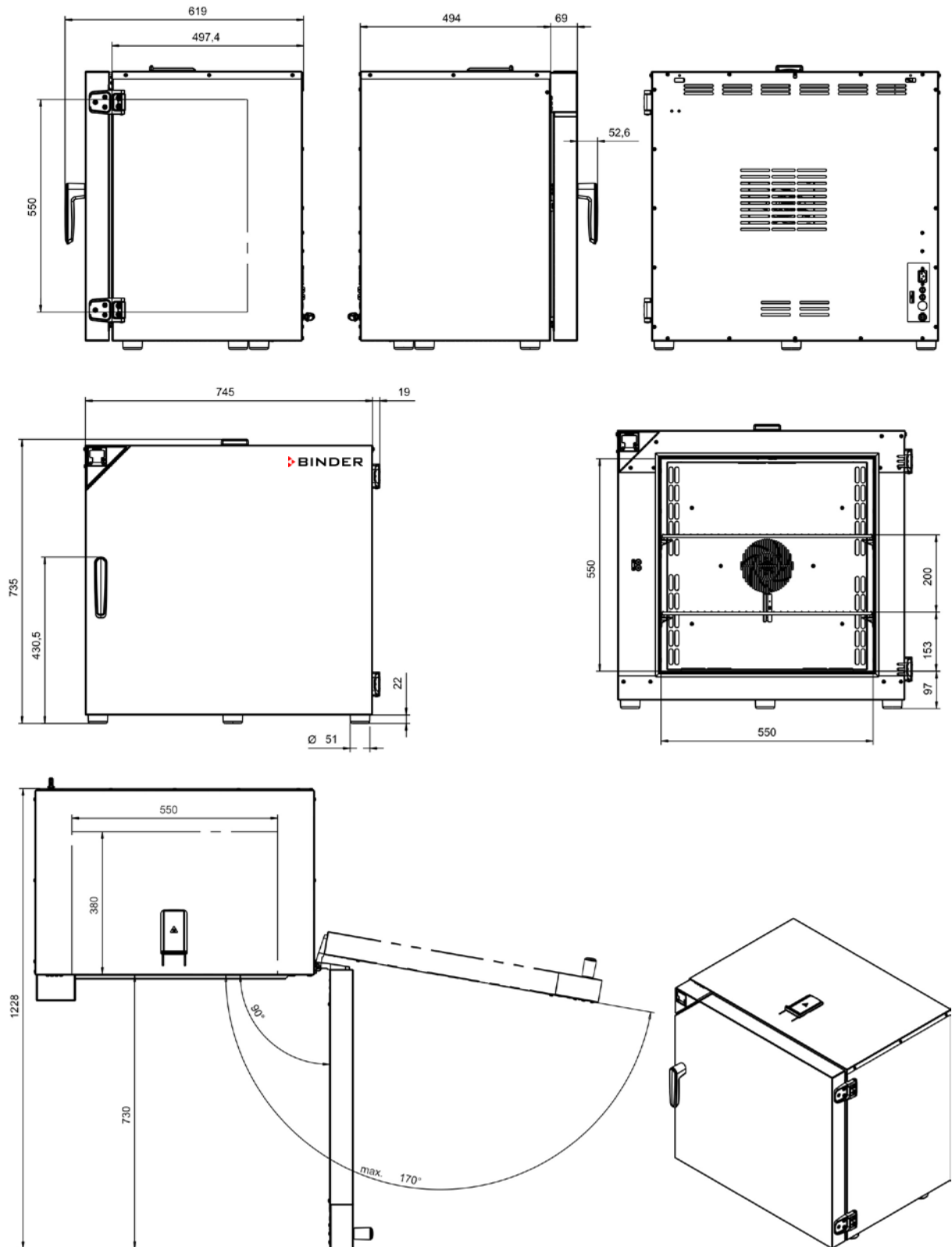

[mm]

16.7.6 FD-S 115



[mm]

17. Certificates and declarations of conformity

17.1 EU Declaration of Conformity for BD-S



Best conditions for your success

	EU-Konformitätserklärung / EU Declaration of Conformity / Déclaration de conformité UE / Declaración de conformidad UE / Dichiarazione di conformità UE / Декларация соответствия EU
Hersteller / Manufacturer / Fabricant / Fabricante / Fabbicante / Производитель	BINDER GmbH
Anschrift / Address / Adresse / Dirección / Indirizzo / Адрес	Im Mittleren Ösch 5, 78532 Tuttlingen, Germany
Produkt / Product / Produit / Producto / Prodotto / Продукт	Inkubatoren mit freier Konvektion Incubators with natural convection Incubateurs à convection naturelle Incubadoras de convección natural Incubatori a convezione naturale Инкубаторы с естественной конвекцией
Typenbezeichnung / Type / Type / Tipo / Tipo / Тип	BD-S 56, BD-S 115

Das oben beschriebene Produkt ist konform mit folgenden EU-Richtlinien:
 The product described above is in conformity with the following EU Directives:
 Le produit décrit ci-dessus est conforme aux directives UE suivantes:
 El producto descrito arriba cumple con las siguientes directivas de la UE:
 Il prodotto sopra descritto è conforme alle seguenti direttive UE:
 Продукты, указанные выше, полностью соответствуют следующим EU руководствам:

<ul style="list-style-type: none"> • 2014/35/EU Niederspannungsrichtlinie 2014/35/EU / Low voltage directive 2014/35/EU / Directive basse tension 2014/35/UE / Directiva sobre baja tensión 2014/35/UE / Direttiva Bassa tensione 2014/35/UE / Директива по низкому напряжению 2014/35/EU • 2014/30/EU EMV-Richtlinie 2014/30/EU / EMC Directive 2014/30/EU / Directive CEM 2014/30/UE / Directiva CEM 2014/30/UE / Direttiva EMC 2014/30/UE / Директива ЭМС 2014/30/EU • 2011/65/EU RoHS-Richtlinie 2011/65/EU / RoHS Directive 2011/65/EU / Directive RoHS 2011/65/UE / Directiva RoHS 2011/65/UE / Direttiva RoHS 2011/65/UE / Директива RoHS 2011/65/EU

Die oben beschriebenen Produkte tragen entsprechend die Kennzeichnung CE.
 The products described above, corresponding to this, bear the CE-mark.
 Les produits décrits ci-dessus, en correspondance, portent l'indication CE.
 Los productos descritos arriba, en conformidad, llevan la indicación CE.
 I prodotti sopra descritti, conformi a quanto sopra, portano il marchio CE.
 Данные продукты в соответствии с изложенным выше маркированы знаком CE.

1 / 2

BINDER GmbH Postfach 102 D-78502 Tuttlingen **Anschrift:** BINDER GmbH Im Mittleren Ösch 5 D-78532 Tuttlingen
Kontakt: Telefon: +49 (0) 74 62 / 20 05 – 0 | Telefax: +49 (0) 74 62 / 20 05 – 100 | info@binder-world.com | www.binder-world.com
Geschäftsführung: Dipl.-Ing. Peter M. Binder | Amtsgericht Stuttgart, HRB 727150 | Sitz der Gesellschaft: Tuttlingen
Bankverbindung: Kreissparkasse Tuttlingen Konto-Nr.: 2268 BLZ: 643 500 70 | IBAN-Code: DE05643 500700 000002268 | SWIFT-Code: SOLA DE 51TUT
 S-Account 2202 611 55 | IBAN-Code: DE7464350070 0220 261155 | SWIFT-Code: SOLA DE 51TUT
 Deutsche Bank Tuttlingen Konto-Nr.: 2 138 709 BLZ: 653 700 75 | IBAN-Code: DE56653 70075 0213870900 | SWIFT-Code: DEUT DE 55603
 Allgeräte-Entsorgung gemäß WEEE-Reg.-Nr. DE 37004983

Die oben beschriebenen Produkte sind konform mit folgenden harmonisierten Normen:
The products described above are in conformity with the following harmonized standards:
Les produits décrits ci-dessus sont conformes aux normes harmonisées suivantes:
Los productos descritos arriba cumplen con las siguientes normas:
I prodotti sopra descritti sono conformi alle seguenti normative armonizzate:
Продукты, указанные выше, полностью соответствуют следующим стандартам:

Sicherheit / Safety / Sécurité / Seguridad / Sicurezza / Нормативы по безопасности
<ul style="list-style-type: none">• EN 61010-1:2010• EN 61010-2-010:2014
EMV / EMC / CEM / CEM / EMC / ЭМС
<ul style="list-style-type: none">• EN 61326-1:2013
RoHS
<ul style="list-style-type: none">• EN 50581:2012

78532 Tuttlingen, 07.05.2018
BINDER GmbH

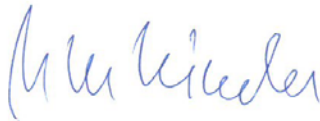

P. M. Binder
Geschäftsführender Gesellschafter
Managing Director
Directeur général
Director general
Direttore Generale
Генеральный Директор



J. Bollaender
Leiter F & E
Director R & D
Chef de service R&D
Responsable I & D
Direttore R & D
Глава департамента R&D

2 / 2

BINDER GmbH Postfach 102, D-78502 Tuttlingen | **Anschrift:** BINDER GmbH, Im Mittleren Ösch 5, D-78532 Tuttlingen
Kontakt: Telefon: +49 (0) 74 62 / 20 05 - 0 | Telefax: +49 (0) 74 62 / 20 05 - 100 | info@binder-world.com | www.binder-world.com
Geschäftsführung: Dipl.-Ing. Peter M. Binder | Amtsgericht Stuttgart, HRB 727150 | Sitz der Gesellschaft: Tuttlingen
Bankverbindung: Kreissparkasse Tuttlingen, Konto-Nr.: 2266, BLZ: 643 500 70 | IBAN-Code: DE05643 500700 000002266 | SWIFT-Code: SOLA DE 31TUT
S-Account 2202 611 55 | IBAN-Code: DE7464350070 0220 261155 | SWIFT-Code: SOLA DE 31TUT
Deutsche Bank Tuttlingen, Konto-Nr.: 2 138 709, BLZ: 653 700 75 | IBAN-Code: DE56653 70075 0213870900 | SWIFT-Code: DEUT DE 3303
Altgeräte-Entsorgung gemäß WEEE-Reg.-Nr. DE 37004983

17.2 EU Declaration of Conformity for ED-S



CE EU-Konformitätserklärung / EU Declaration of Conformity / Déclaration de conformité UE / Declaración de conformidad UE / Dichiarazione di conformità UE / Декларация соответствия EU

Hersteller / Manufacturer / Fabricant / Fabricante / Fabbicante / Производитель	BINDER GmbH
Anschrift / Address / Adresse / Dirección / Indirizzo / Адрес	Im Mittleren Ösch 5, 78532 Tuttlingen, Germany
Produkt / Product / Produit / Producto / Prodotto / Продукт	Trocken- und Wärmeschränke mit freier Konvektion Drying and heating ovens with natural convection Etuves de chauffage et de séchage à convection naturelle Estufas de secado y calentamiento de convección natural Stufe per essiccazione e riscaldamento a convezione naturale Сушильные и сухожаровые шкафы с естественной конвекцией
Typenbezeichnung / Type / Type / Tipo / Tipo / Тип	ED-S 56, ED-S 115

Das oben beschriebene Produkt ist konform mit folgenden EU-Richtlinien:

The product described above is in conformity with the following EU Directives:

Le produit décrit ci-dessus est conforme aux directives UE suivantes:

El producto descrito arriba cumple con las siguientes directivas de la UE:

Il prodotto sopra descritto è conforme alle seguenti direttive UE:

Продукты, указанные выше, полностью соответствуют следующим EU руководствам:

- **2014/35/EU**
Niederspannungsrichtlinie 2014/35/EU / Low voltage directive 2014/35/EU / Directive basse tension 2014/35/UE / Directiva sobre baja tensión 2014/35/UE / Direttiva Bassa tensione 2014/35/UE / Директива по низкому напряжению 2014/35/EU
- **2014/30/EU**
EMV-Richtlinie 2014/30/EU / EMC Directive 2014/30/EU / Directive CEM 2014/30/UE / Directiva CEM 2014/30/UE / Direttiva EMC 2014/30/UE / Директива ЭМС 2014/30/EU
- **2011/65/EU**
RoHS-Richtlinie 2011/65/EU / RoHS Directive 2011/65/EU / Directive RoHS 2011/65/UE / Directiva RoHS 2011/65/UE / Direttiva RoHS 2011/65/UE / Директива RoHS 2011/65/EU

Die oben beschriebenen Produkte tragen entsprechend die Kennzeichnung CE.

The products described above, corresponding to this, bear the CE-mark.

Les produits décrits ci-dessus, en correspondance, portent l'indication CE.

Los productos descritos arriba, en conformidad, llevan la indicación CE.

I prodotti sopra descritti, conformi a quanto sopra, portano il marchio CE.

Данные продукты в соответствии с изложенным выше маркированы знаком CE.

1 / 2

BINDER GmbH Postfach 102 D-78502 Tuttlingen **Anschrift:** BINDER GmbH Im Mittleren Ösch 5 D-78532 Tuttlingen
Kontakt: Telefon: +49 (0) 74 62 / 20 05 – 0 | Telefax: +49 (0) 74 62 / 20 05 – 100 | info@binder-world.com | www.binder-world.com
Geschäftsführung: Dipl.-Ing. Peter M. Binder | Amtsgericht Stuttgart, HRB 727150 | Sitz der Gesellschaft: Tuttlingen
Bankverbindung: Kreissparkasse Tuttlingen Konto-Nr.: 2266 BLZ: 643 500 70 | IBAN-Code: DE05643 600700 000002266 | SWIFT-Code: SOLA DE S1TUT
S-Account: 2202 611 55 | IBAN-Code: DE7464350070 0220 261155 | SWIFT-Code: SOLA DE S1TUT
Deutsche Bank Tuttlingen: Konto-Nr.: 2 138 709 BLZ: 653 700 75 | IBAN-Code: DE56653 70075 0213870900 | SWIFT-Code: DEUT DE SS603
 Altgeräte-Entsorgung gemäß WEEE-Reg.-Nr. DE 37004983

Die oben beschriebenen Produkte sind konform mit folgenden harmonisierten Normen:
The products described above are in conformity with the following harmonized standards:
Les produits décrits ci-dessus sont conformes aux normes harmonisées suivantes:
Los productos descritos arriba cumplen con las siguientes normas:
I prodotti sopra descritti sono conformi alle seguenti normative armonizzate:
Продукты, указанные выше, полностью соответствуют следующим стандартам:

Sicherheit / Safety / Sécurité / Seguridad / Sicurezza / Нормативы по безопасности
<ul style="list-style-type: none">• EN 61010-1:2010• EN 61010-2-010:2014
EMV / EMC / CEM / CEM / EMC / ЭМС
<ul style="list-style-type: none">• EN 61326-1:2013
RoHS
<ul style="list-style-type: none">• EN 50581:2012

78532 Tuttlingen, 07.05.2018
BINDER GmbH

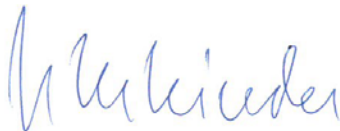

P. M. Binder
Geschäftsführender Gesellschafter
Managing Director
Directeur général
Director general
Direttore Generale
Генеральный Директор



J. Bollaender
Leiter F & E
Director R & D
Chef de service R&D
Responsable I & D
Direttore R & D
Глава департамента R&D

2 / 2

BINDER GmbH Postfach 102 D-78502 Tuttlingen **Anschrift:** BINDER GmbH Im Mittleren Ösch 5 D-78532 Tuttlingen
Kontakt: Telefon: +49 (0) 74 62 / 20 05 – 0 | Telefax: +49 (0) 74 62 / 20 05 – 100 | info@binder-world.com | www.binder-world.com
Geschäftsführung: Dipl.-Ing. Peter M. Binder | Amtsgericht Stuttgart, HRB 727150 | Sitz der Gesellschaft: Tuttlingen
Bankverbindung: Kreissparkasse Tuttlingen Konto-Nr.: 2266 BLZ: 643 500 70 | IBAN-Code: DE05643 500700 000002266 | SWIFT-Code: SOLA DE S1TUT
S-Account 2202 611 55 | IBAN-Code: DE7464350070 0220 261155 | SWIFT-Code: SOLA DE S1TUT
Deutsche Bank Tuttlingen Konto-Nr.: 2 138 709 BLZ: 653 700 75 | IBAN-Code: DE56653 70075 0213870900 | SWIFT-Code: DEUT DE SS603
Altgeräte-Entsorgung gemäß WEEE-Reg.-Nr. DE 37004983

17.3 EU Declaration of Conformity for FD-S



CE EU-Konformitätserklärung / EU Declaration of Conformity / Déclaration de conformité UE / Declaración de conformidad UE / Dichiarazione di conformità UE / Декларация соответствия EU

Hersteller / Manufacturer / Fabricant / Fabricante / Fabbrikante / Производитель	BINDER GmbH
Anschrift / Address / Adresse / Dirección / Indirizzo / Адрес	Im Mittleren Ösch 5, 78532 Tuttlingen, Germany
Produkt / Product / Produit / Producto / Prodotto / Продукт	Trocken- und Wärmeschränke mit Umluft Drying and heating ovens with forced convection Etuves de chauffage et de séchage à convection forcée Estufas de secado y calentamiento de convección forzada Stufe per essiccazione e riscaldamento a convezione forzata Сушильные и сухожаровые шкафы с принудительной конвекцией
Typenbezeichnung / Type / Type / Tipo / Tipo / Тип	FD-S 56, FD-S 115

Das oben beschriebene Produkt ist konform mit folgenden EU-Richtlinien:

The product described above is in conformity with the following EU Directives:

Le produit décrit ci-dessus est conforme aux directives UE suivantes:

El producto descrito arriba cumple con las siguientes directivas de la UE:

Il prodotto sopra descritto è conforme alle seguenti direttive UE:

Продукты, указанные выше, полностью соответствуют следующим EU руководствам:

- **2014/35/EU**
Niederspannungsrichtlinie 2014/35/EU / Low voltage directive 2014/35/EU / Directive basse tension 2014/35/UE / Directiva sobre baja tensión 2014/35/UE / Direttiva Bassa tensione 2014/35/UE / Директива по низкому напряжению 2014/35/EU
- **2014/30/EU**
EMV-Richtlinie 2014/30/EU / EMC Directive 2014/30/EU / Directive CEM 2014/30/UE / Directiva CEM 2014/30/UE / Direttiva EMC 2014/30/UE / Директива ЭМС 2014/30/EU
- **2011/65/EU**
RoHS-Richtlinie 2011/65/EU / RoHS Directive 2011/65/EU / Directive RoHS 2011/65/UE / Directiva RoHS 2011/65/UE / Direttiva RoHS 2011/65/UE / Директива RoHS 2011/65/EU

Die oben beschriebenen Produkte tragen entsprechend die Kennzeichnung CE.

The products described above, corresponding to this, bear the CE-mark.

Les produits décrits ci-dessus, en correspondance, portent l'indication CE.

Los productos descritos arriba, en conformidad, llevan la indicación CE.

I prodotti sopra descritti, conformi a quanto sopra, portano il marchio CE.

Данные продукты в соответствии с изложенным выше маркированы знаком CE.

1 / 2

BINDER GmbH Postfach 102 D-78502 Tuttlingen **Anschrift:** BINDER GmbH Im Mittleren Ösch 5 D-78532 Tuttlingen
Kontakt: Telefon: +49 (0) 74 62 / 20 05 – 0 | Telefax: +49 (0) 74 62 / 20 05 – 100 | info@binder-world.com | www.binder-world.com
Geschäftsführung: Dipl.-Ing. Peter M. Binder | Amtsgericht Stuttgart, HRB 727150 | Sitz der Gesellschaft: Tuttlingen
Bankverbindung: Kreissparkasse Tuttlingen Konto-Nr.: 2266 BLZ: 643 500 70 | IBAN-Code: DE05643 500700 000002266 | SWIFT-Code: SOLA DE S1TUT
S-Account 2202 611 55 | IBAN-Code: DE7464350070 0220 261155 | SWIFT-Code: SOLA DE S1TUT
Deutsche Bank Tuttlingen Konto-Nr.: 2 138 709 BLZ: 653 700 75 | IBAN-Code: DE56653 70075 0213870900 | SWIFT-Code: DEUT DE SS603
 Altgeräte-Entsorgung gemäß WEEE-Reg.-Nr. DE 37004983

Die oben beschriebenen Produkte sind konform mit folgenden harmonisierten Normen:
The products described above are in conformity with the following harmonized standards:
Les produits décrits ci-dessus sont conformes aux normes harmonisées suivantes:
Los productos descritos arriba cumplen con las siguientes normas:
I prodotti sopra descritti sono conformi alle seguenti normative armonizzate:
Продукты, указанные выше, полностью соответствуют следующим стандартам:

Sicherheit / Safety / Sécurité / Seguridad / Sicurezza / Нормативы по безопасности
<ul style="list-style-type: none">• EN 61010-1:2010• EN 61010-2-010:2014
EMV / EMC / CEM / CEM / EMC / ЭМС
<ul style="list-style-type: none">• EN 61326-1:2013
RoHS
<ul style="list-style-type: none">• EN 50581:2012

78532 Tuttlingen, 07.05.2018
BINDER GmbH



P. M. Binder
Geschäftsführender Gesellschafter
Managing Director
Directeur général
Director general
Direttore Generale
Генеральный Директор



J. Bollaender
Leiter F & E
Director R & D
Chef de service R&D
Responsable I & D
Direttore R & D
Глава департамента R&D

2 / 2

BINDER GmbH Postfach 102 D-78502 Tuttlingen **Anschrift:** BINDER GmbH Im Mittleren Ösch 5 D-78532 Tuttlingen
Kontakt: Telefon: +49 (0) 74 62 / 20 05 – 0 | Telefax: +49 (0) 74 62 / 20 05 – 100 | info@binder-world.com | www.binder-world.com
Geschäftsführung: Dipl.-Ing. Peter M. Binder | Amtsgericht Stuttgart, HRB 727150 | Sitz der Gesellschaft: Tuttlingen
Bankverbindung: Kreissparkasse Tuttlingen Konto-Nr.: 2266 BLZ: 643 500 70 | IBAN-Code: DE05643 500700 000002266 | SWIFT-Code: SOLA DE 31TUT
S-Account 2202 611 55 | IBAN-Code: DE7464350070 0220 261155 | SWIFT-Code: SOLA DE 31TUT
Deutsche Bank Tuttlingen Konto-Nr.: 2 138 709 BLZ: 653 700 75 | IBAN-Code: DE56653 70075 0213870900 | SWIFT-Code: DEUT DE 33803
Altgeräte-Entsorgung gemäß WEEE-Reg.-Nr. DE 37004983

18. Product registration

Online Product Registration

Register your BINDER now!

www.binder-world.com/register

The registration is free and takes just a few seconds

Advantages:

- ▶ Short response times if service is needed
- ▶ Fair prices when relocating or installing equipment
- ▶ Calibration as required at no charge in case of recalls
- ▶ Free information on news, product upgrades and accessories

Easy registered in 3 steps:



1. List serial number here: -

2. Go online: www.binder-world.com/register

3. Register serial number

19. Contamination clearance certificate

19.1 For chambers located outside the USA and Canada

Declaration with regard to safety and health

Erklärung zur Sicherheit und gesundheitlichen Unbedenklichkeit

The German Ordinance on Hazardous Substances (GefStofV), and the regulations regarding safety at the workplace, require that this form be filled out for all products that are returned to us, so that the safety and health of our employees can be warranted.

Die Sicherheit und Gesundheit unserer Mitarbeiter, die Gefahrstoffverordnung GefStofV und die Vorschriften zur Sicherheit am Arbeitsplatz machen es erforderlich, dass dieses Formblatt für alle Produkte, die an uns zurückgeschickt wird.

	<p>In the absence of a completely filled out form, a repair is not possible. Ohne Vorliegen des vollständig ausgefüllten Formblattes ist eine Reparatur nicht möglich.</p>
---	--

- A completely filled out form should be transmitted by Fax (+49 (0) 7462 2005 93555) or by letter in advance to us, so that this information is available before the equipment/component part arrives. A second copy of this form should accompany the equipment/component part. Eventually the carrier should be informed.

Eine vollständig ausgefüllte Kopie dieses Formblattes soll per Telefax (Nr. +49 (0) 7462 2005 93555) oder Brief vorab an uns gesandt werden, so dass die Information vorliegt, bevor das Gerät/Bauteil eintrifft. Eine weitere Kopie soll dem Gerät/Bauteil beigelegt sein. Ggf. ist auch die Spedition zu informieren.

- Incomplete information or non-conformity with this procedure will inevitably lead to substantial delays in processing. We hope you will have understanding for this measure, which lies outside of our area of influence, and that you will help us to speed up this procedure.

Unvollständige Angaben oder Nichteinhalten dieses Ablaufs führen zwangsläufig zu beträchtlichen Verzögerungen in der Abwicklung. Bitte haben Sie Verständnis für Maßnahmen, die außerhalb unserer Einflussmöglichkeiten liegen und helfen Sie mit, den Ablauf beschleunigen.

- **Please fill out this form completely.**

Bitte unbedingt vollständig ausfüllen!

1.	Chamber/ component part / type: / Gerät / Bauteil / Typ:
2.	Serial No./ Serien-Nr.:
3.	Details about utilized substances / biological substances / Einzelheiten über die eingesetzten Substanzen/biologische Materialien:
3.1	Designations / Bezeichnungen:
a)	_____
b)	_____
c)	_____
3.2	Safety measures required for handling these substances / Vorsichtsmaßnahmen beim Umgang mit diesen Stoffen:
a)	_____
b)	_____
c)	_____

3.3	Measures to be taken in case of skin contact or release into the atmosphere / Maßnahmen bei Personenkontakt oder Freisetzung:
a)	_____
b)	_____
c)	_____
d)	_____
3.4	Other important information that must be taken into account / Weitere zu beachtende und wichtige Informationen:
a)	_____
b)	_____
c)	_____
4.	Declaration on the risk of these substances (please checkmark the applicable items) / Erklärung zur Gefährlichkeit der Stoffe (bitte Zutreffendes ankreuzen) :
<input type="checkbox"/>	4.1 For non toxic, non radioactive, biologically harmless materials / für nicht giftige, nicht radioaktive, biologisch ungefährliche Stoffe:
	We herewith guarantee that the above-mentioned chamber / component part... / Wir versichern, dass o.g. Gerät/Bauteil...
<input type="checkbox"/>	Has not been exposed to or contains any toxic or otherwise hazardous substances / weder giftige noch sonstige gefährliche Stoffe enthält oder solche anhaften.
<input type="checkbox"/>	That eventually generated reaction products are non-toxic and also do not represent a hazard / auch evtl. entstandene Reaktionsprodukte weder giftig sind noch sonst eine Gefährdung darstellen.
<input type="checkbox"/>	Eventual residues of hazardous substances have been removed / evtl. Rückstände von Gefahrstoffen entfernt wurden.
<input type="checkbox"/>	4.2 For toxic, radioactive, biologically harmful or hazardous substances, or any other hazardous materials / für giftige, radioaktive, biologisch bedenkliche bzw. gefährliche Stoffe oder anderweitig gefährliche Stoffe.
	We herewith guarantee that ... / Wir versichern, dass ...
<input type="checkbox"/>	The hazardous substances, which have come into contact with the above-mentioned equipment/component part, have been completely listed under item 3.1 and that all information in this regard is complete / die gefährlichen Stoffe, die mit dem o.g. Gerät/Bauteil in Kontakt kamen, in 3.1 aufgelistet sind und alle Angaben vollständig sind.
<input type="checkbox"/>	That the chamber /component part has not been in contact with radioactivity / das Gerät/Bauteil nicht mit Radioaktivität in Berührung kam
5.	Kind of transport / transporter / Transportweg/Spediteur:
	Transport by (means and name of transport company, etc.) Versendung durch (Name Spediteur o.ä.)

	Date of dispatch to BINDER GmbH / Tag der Absendung an BINDER GmbH:

We herewith declare that the following measures have been taken / Wir erklären, dass folgende Maßnahmen getroffen wurden:

- Hazardous substances were removed from the chamber / component part, so that no hazard exists for corresponding persons in the handling or repair of these items / das Gerät/Bauteil wurde von Gefahrstoffen befreit, so dass bei Handhabung/Reparaturen für die betreffenden Person keinerlei Gefährdung besteht
- The chamber was securely packaged and properly identified / das Gerät wurde sicher verpackt und vollständig gekennzeichnet.
- Information about the hazardousness of the shipment (if required) has been provided to the transporter / der Spediteur wurde (falls vorgeschrieben) über die Gefährlichkeit der Sendung informiert.

We herewith commit ourselves and guarantee that we will indemnify BINDER GmbH for all damages that are a consequence of incomplete or incorrect information provided by us, and that we will exempt BINDER GmbH from eventual damage claims by third parties./ Wir versichern, dass wir gegenüber BINDER für jeden Schaden, der durch unvollständige und unrichtige Angaben entsteht, haften und BINDER gegen eventuell entstehende Schadenansprüche Dritter freistellen.

We are aware that, in accordance with Article 823 of the German Civil Code (BGB), we are directly liable with regard to third parties, in this instance especially the employees of BINDER GmbH, who have been entrusted with the handling / repair of the chamber / component. / Es ist uns bekannt, dass wir gegenüber Dritten – hier insbesondere mit der Handhabung/Reparatur des Geräts/des Bauteils betraute Mitarbeiter der Firma BINDER - gemäß §823 BGB direkt haften

Name: _____

Position: _____

Date / Datum: _____

Signature / Unterschrift: _____

Company stamp / Firmenstempel:



Equipment that is returned to the factory for repair must be accompanied by a completely filled out contamination clearance certificate. For service and maintenance works on site, such a contamination clearance certificate must be submitted to the service technician before the start of the works. No repair or maintenance of the equipment is possible, without a properly filled out contamination clearance certificate.

19.2 For chambers located in the USA and Canada

Product Return Authorization Request

Please complete this form and the Customer Decontamination Declaration (next 2 pages) and attach the required pictures. E-mail to: IDL_SalesOrderProcessing_USA@binder-world.com

After we have received and reviewed the complete information we will decide on the issue of a RMA number. Please be aware that size specifications, voltage specifications as well as performance specifications are available on the internet at www.binder-world.us at any time.

Take notice of shipping laws and regulations.

	Please fill:	
Reason for return request	<input type="radio"/> Duplicate order	
	<input type="radio"/> Duplicate shipment	
	<input type="radio"/> Demo	<i>Page one completed by sales</i>
	<input type="radio"/> Power Plug / Voltage	115V / 230 V / 208 V / 240V
	<input type="radio"/> Size does not fit space	
	<input type="radio"/> Transport Damage	Shock watch tripped? (<i>pictures</i>)
	<input type="radio"/> Other (specify below)	

Is there a replacement PO?	<input type="radio"/> Yes <input type="radio"/> No	
	<i>If yes -> PO #</i>	
	<i>If yes -> Date PO placed</i>	
Purchase order number		
BINDER model number		
BINDER serial number		
Date chamber was received		
Was the chamber unboxed?	<input type="radio"/> Yes <input type="radio"/> No	
Was the chamber plugged in?	<input type="radio"/> Yes <input type="radio"/> No	
Was the chamber in operation?	<input type="radio"/> Yes <input type="radio"/> No	
<i>Pictures of chamber attached?</i>	<input type="radio"/> Yes <input type="radio"/> No	Pictures have to be attached!
<i>Pictures of Packaging attached?</i>	<input type="radio"/> Yes <input type="radio"/> No	

	Customer Contact Information	Distributor Contact Information
Name		
Company		
Address		
Phone		
E-mail		

Customer (End User) Decontamination Declaration

Health and Hazard Safety declaration

To protect the health of our employees and the safety at the workplace, we require that this form is completed by the user for all products and parts that are returned to us. (Distributors or Service Organizations cannot sign this form)

	<p>NO RMA number will be issued without a completed form. Products or parts returned to our NY warehouse without a RMA number will be refused at the dock.</p>
---	--

A second copy of the completed form must be attached to the outside of the shipping box.

<p>1. Chamber/ component part / type:</p>
<p>2. Serial No.</p>
<p>3. List any exposure to hazardous liquids, gasses or substances and radioactive material</p>
<p>3.1 List with MSDS sheets attached where available or needed (if there is not enough space available below, please attach a page):</p> <p>a) _____</p> <p>b) _____</p> <p>c) _____</p>
<p>3.2 Safety measures required for handling the list under 3.1</p> <p>a) _____</p> <p>b) _____</p> <p>c) _____</p>
<p>3.3 Measures to be taken in case of skin contact or release into the atmosphere:</p> <p>a) _____</p> <p>b) _____</p> <p>c) _____</p> <p>d) _____</p>
<p>3.4 Other important information that must be considered:</p> <p>a) _____</p> <p>b) _____</p> <p>c) _____</p>

4. Declaration of Decontamination

For toxic, radioactive, biologically and chemically harmful or hazardous substances, or any other hazardous materials.

We hereby guarantee that

- 4.1 Any hazardous substances, which have come into contact with the above-mentioned equipment / component part, have been completely listed under item 3.1 and that all information in this regard is complete.
- 4.2 That the chamber /component part has not been in contact with radioactivity
- 4.3 Any Hazardous substances were removed from the chamber / component part, so that no hazard exists for a persons in the shipping, handling or repair of these returned chamber
- 4.4 The chamber was securely packaged in the original undamaged packaging and properly identified on the outside of the packaging material with the chamber designation, the RMA number and a copy of this declaration.
- 4.5 Shipping laws and regulations have not been violated.

I hereby commit and guarantee that we will indemnify BINDER Inc. for all damages that are a consequence of incomplete or incorrect information provided by us, and that we will indemnify and hold harmless BINDER Inc. from eventual damage claims by third parties.

Name: _____

Position: _____

Company: _____

Address: _____

Phone #: _____

Email: _____

Date: _____

Signature: _____



Equipment returned to the NY warehouse for repair must be accompanied by a completed customer decontamination declaration. For service and maintenance works on site, such a customer decontamination declaration must be submitted to the service technician before the start of work. No repair or maintenance of the equipment is possible without a completed form.

